

CAM		
POSITION	H : GRIP	H : GRIP
	MIN	MAX
UP	35	54
DOWN	57	72

NOTE

MATERIAL

BODY: STEEL
 HANDLE: ZAMAK ZNAL4CU1
 CAM : STEEL
 SCREW: STAINLESS STEEL
 SEAL : POLYURETHANE

FINISH BODY : BLACK COATED
 FINISH HANDLE : BLACK COATED

CYLINDER : EURO KEY (5333)

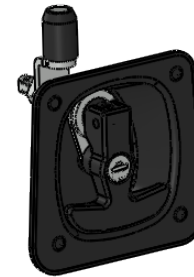

1:4

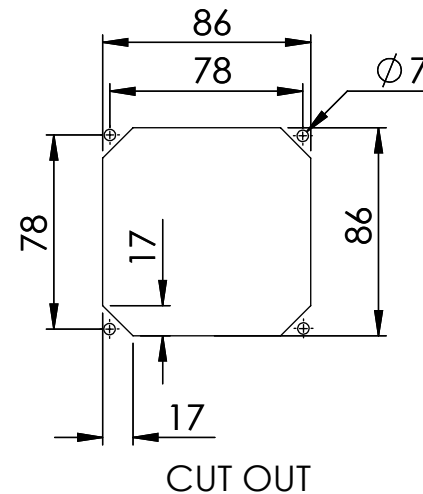
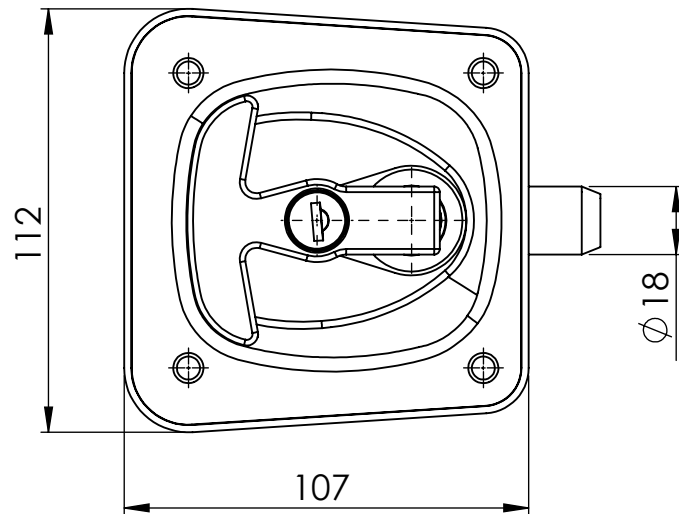

APPROVED - UNCONTROLLED



© 2013 Essentra Components. All rights reserved.
 Registered in England, Company No. 547495.
 Registered Office: Avebury House,
 201-249 Avebury Boulevard, Milton Keynes, MK9 1AU

Condition of Sale can be found on our website: essentra.com.

Essentra Components does not warrant that the files will be error free and may create new versions ("Upgrades") at any time, which may correct such errors. Essentra Components has no obligation to notify you of such upgrades. Any upgraded file will be published to the website, when it becomes available.

You are not permitted to load any of the files on to a network server for the purposes of distribution to one or more other computer(s) on that network or to effect such distribution. Essentra Components shall not be liable for any loss or damage whatsoever or however caused, arising directly or indirectly from the use of the files.

UNLESS OTHERWISE STATED

ALL DIMENSIONS IN mm	DO NOT SCALE
LINEAR TOLERANCE	THIRD ANGLE PROJECTION
SIZE (0) (0.0) (0.00)	
0-10mm ±0.5 ±0.15 ±0.10	ANGULAR TOLERANCE ±0.5 DEGREES
>10-30 ±0.5 ±0.20 ±0.15	UNSPECIFIED RADII 0.25mm
>30-50 ±0.5 ±0.30 ±0.20	DRAFT ANGLE 0.5 DEGREES
>50-100 ±0.8 ±0.50 ±0.25	DIMENSIONS IN BRACKETS [] ARE IN INCHES FOR REFERENCE ONLY
>100-200 ±1.5 ±0.80 ±0.40	
>200-300 ±2.0 ±1.20 ±0.80	
>300-500 ±3.0 ±2.00 ±1.00	
>500 ±5.0 ±3.00 ±1.50	

ORG. SCALE: 1:2 CREATE DATE: 14/07/2020

MATERIAL: SEE NOTES

Part ID: 1573740 Project: 4013140-1

TITLE: T HANDLE HEAVY-DUTY LOCK

DWG. No. 214120501E SHEET 1 of 1 ISSUE 1