

AV2-UND/ODER-PS-IBS

Anschlussverteiler
 Connection distributor
 Boîtier de raccordement

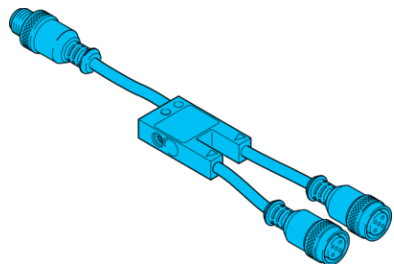

di-soric GmbH & Co. KG
 Steinbeisstraße 6
 DE-73660 Urbach
 Germany
 Tel: +49 (0) 7181/9879-0
 info@di-soric.de · www.di-soric.com

204382



Stand 17.12.21, Änderungen vorbehalten
 As of 12/17/21, subject to change
 État 17.12.21, sous réserve de modifications

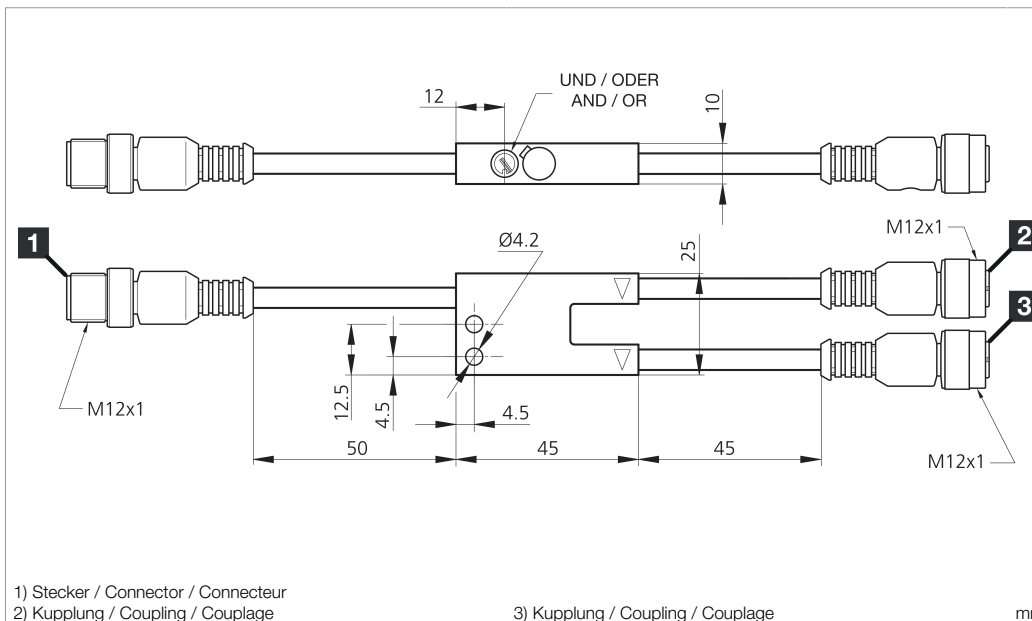

1) Stecker / Connector / Connecteur
 2) Kupplung / Coupling / Couplage

3) Kupplung / Coupling / Couplage

mm

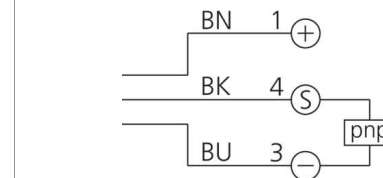

BK : schwarz / black / noir
 BN : braun / brown / marron BU : blau / blue / bleu

Technische Daten	Technical data	Caractéristiques techniques	+20°C, 24 V DC
Funktionsprinzip	Operating principle	Principe de fonctionnement	UND/ODER / AND/OR / ET/OU
Betriebsspannung	Service voltage	Tension de service	10 ... 35 V DC
Leerlaufstrom (max.)	No-load current (max.)	Courant de marche à vide (max.)	14 mA
Funktionsauswahl	Function selection	Sélection de fonctions	200 mA, UND/ODER / 200 mA, AND/OR / 200 mA, ET/OU
Umgebungstemperatur Betrieb	Ambient temperature during operation	Température ambiante de fonctionnement	-25 ... +70 °C
Schutzart	Protection type	Indice de protection	IP 67
Anschluss 1	Connection 1	Raccordement 1	Pigtail Stecker, M12, 3-polig / Pigtail Connector, M12, 3-pin / Pigtail Connecteur, M12, 3 pôles
Anschluss 2	Connection 2	Raccordement 2	Pigtail Buchse M12, 3-polig (2x) / Pigtail Socket M12, 3-pin (2x) / Pigtail Connecteur femelle M12, 3 pôles (2x)

Sicherheitshinweise	Safety instructions	Consignes de sécurité
Allgemeiner Sicherheitshinweis WARNUNG! Kein Sicherheitsbauteil gemäß 2006/42/EG und EN 61496-1 /-2! Darf nicht zum Personenschutz eingesetzt werden! Nichtbeachtung kann zu Tod oder schwersten Verletzungen führen! Nur bestimmungsgemäß verwenden!	General safety notice WARNING! Not a safety component pursuant to 2006/42/EG and EN 61496-1/-2! May not be used for personal protection! Non-compliance can lead to death or serious injuries! Only use as directed!	Consigne de sécurité générale AVERTISSEMENT ! Ce produit n'est pas un composant de sécurité au sens des réglementations 2006/42/CE et NF EN 61496-1/-2 ! Ne pas l'utiliser pour la protection des personnes ! Le non-respect de cette consigne peut entraîner la mort ou des blessures graves ! N'utiliser le produit que selon son utilisation conforme !

AV2-UND/ODER-PS-IBS

连接分线器

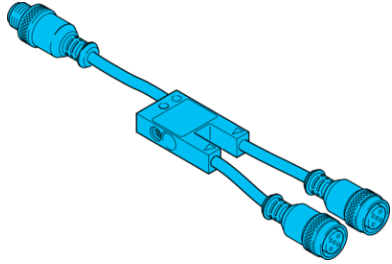

di-soric GmbH & Co. KG
 Steinbeisstraße 6
 DE-73660 Urbach
 Germany
 Tel: +49 (0) 7181/9879-0
 info@di-soric.de · www.di-soric.com

204382



版本 21.12.17, 保留变更权

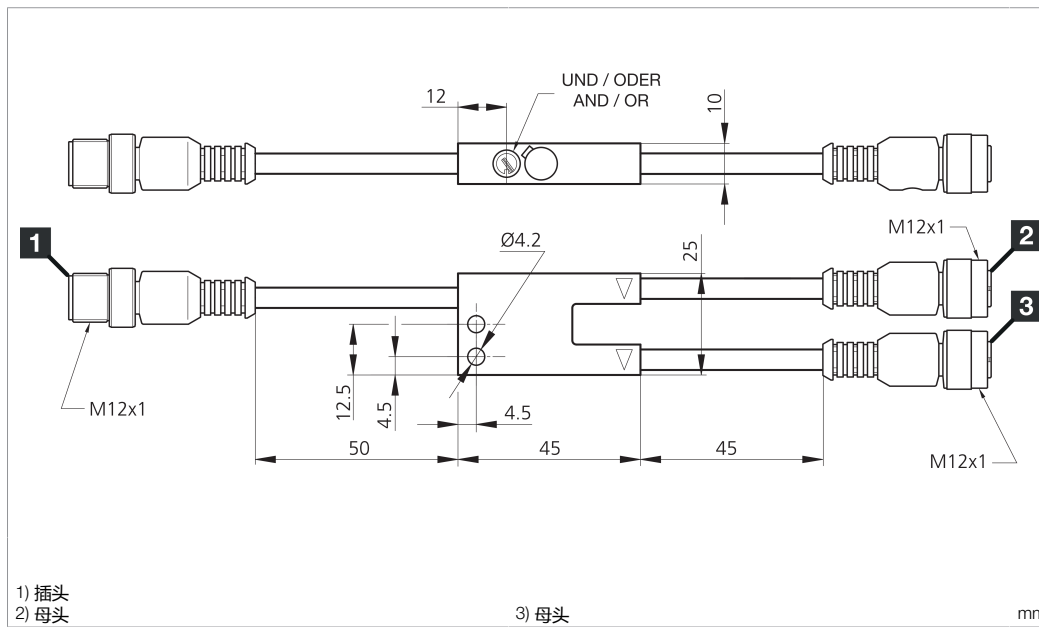

1) 插头
 2) 母头

3) 母头

mm

BK : 黑色
 BN : 棕色

BU : 蓝色

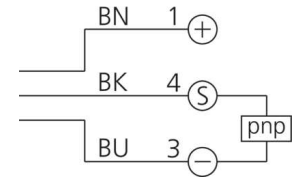

技术数据

工作原理

工作电压

空载电流 (最大)

功能选择

工作环境温度

防护等级

连接 1

连接 2

+20°C, 24 V DC

AND/OR

10 ... 35 V DC

14 mA

200 mA, AND/OR

-25 ... +70 °C

IP 67

电缆/插头 插头, M12, 3 针

电缆/插头 插口 M12, 3 针 (2x)

安全提示



一般安全提示

警告！没有符合 2006/42/EU 和 EN 61496-1 /-2 标准的安全结构件！不得用于人身安全保护！不遵守规定会导致死亡或重伤危险！仅按规定使用！

AV2_UND/ODER-PS-TS

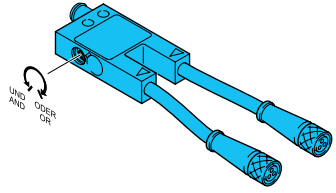

AV2_UND/ODER-PS-IBS

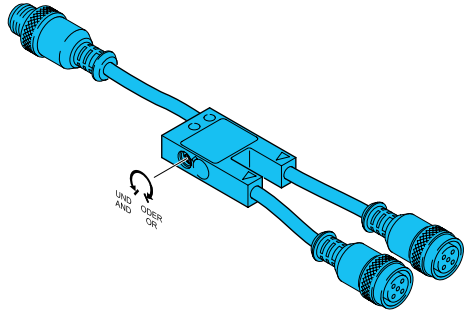

Schaltfunktion:
UND

Switching function:
AND

Fréquence de fonctionnement:
ET

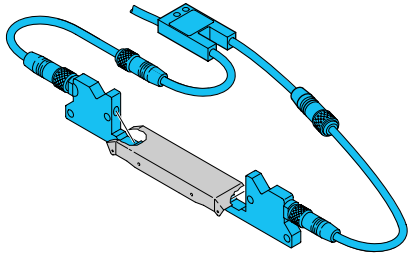

Schaltfunktion:
ODER

Switching function:
OR

Fréquence de fonctionnement:
OU

