

### Technische Daten / Technical Data

Isolierkörper	Thermoplast, nach UL94 V-0
<i>Insulator</i>	<i>Thermoplastic, rated UL94 V-0</i>
Kontaktmaterial	Kupferlegierung
<i>Contact Material</i>	<i>Copper alloy</i>
Kontaktoberfläche	Gold über Nickel
<i>Contact Surface</i>	<i>Gold over Nickel</i>
Oberfläche Lötanschluss	Zinn über Nickel
<i>Plating Solder Side</i>	<i>Tin plated over Nickel</i>
Durchgangswiderstand	< 20 mΩ
<i>Contact Resistance</i>	< 20 mΩ
Isolationswiderstand	> 500 MΩ
<i>Insulation Resistance</i>	> 500 MΩ
Spannungsfestigkeit	1 kV RMS
<i>Test Voltage</i>	<i>1 kV RMS</i>
Nennstrom	1,5 A
<i>Current Rating</i>	<i>1.5 A</i>
Temperaturbereich	-25 °C ... +85 °C
<i>Temperature Range</i>	<i>-25 °C ... +85 °C</i>
Verarbeitung	Wellenlötverfahren
<i>Processing</i>	<i>Wave soldering</i>

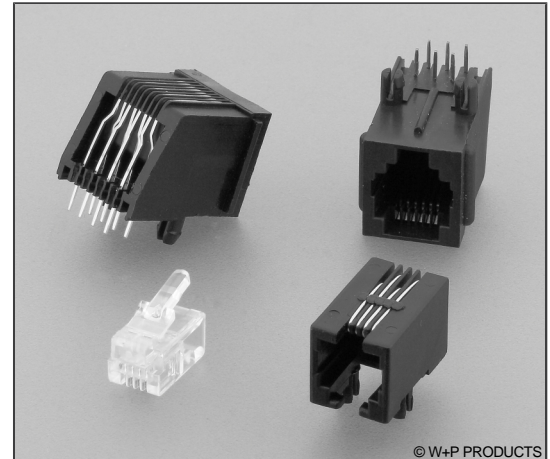

© W+P PRODUCTS

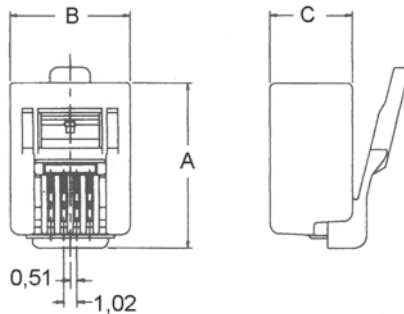

Contacts	A	B	C
<b>04</b>	13,34	7,62	6,60
<b>06</b>	13,34	9,65	6,60
<b>08</b>	22,48	11,68	7,92

Passendes Handwerkzeug auf Wunsch lieferbar.

*Compatible hand tools available by request.*

Buchsen: Cat. 3

Jacks: Cat. 3

Series

**650**

**1**

Type\*

**044**

Für Rundkabel:

*Suited for round cable:*

**044** 4 / 4 (RJ10)

**064** 4 / 6 (RJ11)

**066** 6 / 6 (RJ12)

**088** 8 / 8 (RJ45)

Für Flachkabel:

*Suited for flat cable:*

**144** 4 / 4 (RJ10)

**164** 4 / 6 (RJ11)

**166** 6 / 6 (RJ12)

**188** 8 / 8 (RJ45)

# 650

## Modular-Steckverbinder – Stecker und Einbaubuchsen Modular Jack Connectors – Plugs and Modular Jacks

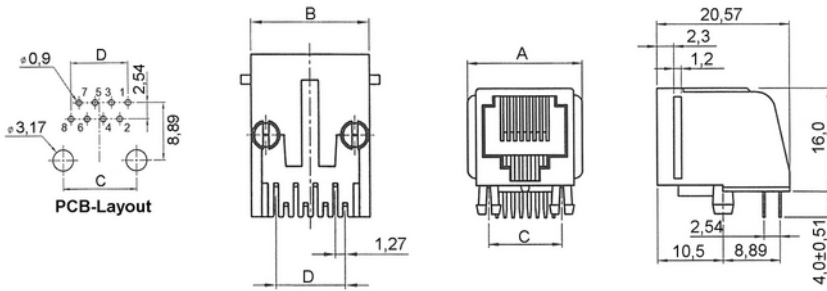

n	A	B	C	D	Pins
04	13,72	11,18	7,62	3,81	3-6
06	15,75	13,21	10,16	6,35	2-7
08	17,78	15,24	11,43	8,89	1-8

Series

**650**

**4**

Contacts \*

**04**

04/06/08

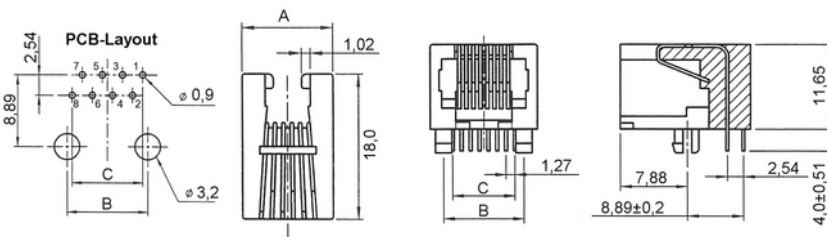

n	A	B	C	Pins
04	11,16	7,62	3,81	3-6
06	13,20	10,16	6,35	2-7
08	15,15	11,43	8,89	1-8

Series

**650**

**5**

Contacts \*

**06**

04/06/08

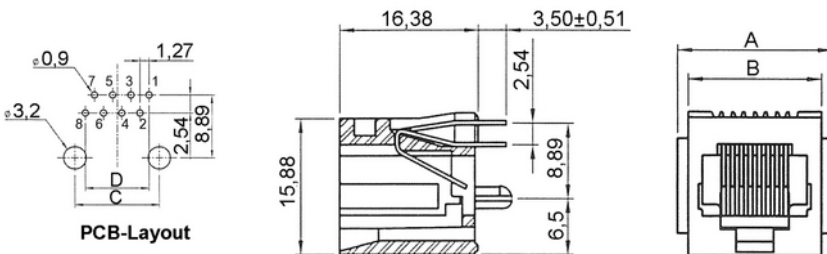

n	A	B	C	D	Pins
04	13,97	11,43	7,62	3,81	3-6
06	16,00	13,46	10,16	6,35	2-7
08	17,84	15,36	11,43	8,89	1-8

Series

**650**

**6**

Contacts \*

**08**

04/06/08



PCB Layout  
4 Contacts

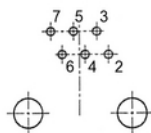

PCB Layout  
6 Contacts



PCB Layout  
8 Contacts

\* Dies ist ein **Bestellbeispiel** - bitte durch Ihre Spezifikationen ersetzen.  
\* This is an **order example** - please replace by your specifications.

## Empfehlungen für das Wellenlötverfahren

### Recommendations for Wave Soldering

Die Bauteile sollten bei einer Lötbadtemperatur von 260°C in max. 5 Sekunden verlötet werden.  
*Items should be soldered at a solder temperature of 260°C in 5 seconds max.*

Empfohlenes Wellenlötprofil:  
*Recommended wave soldering profile:*

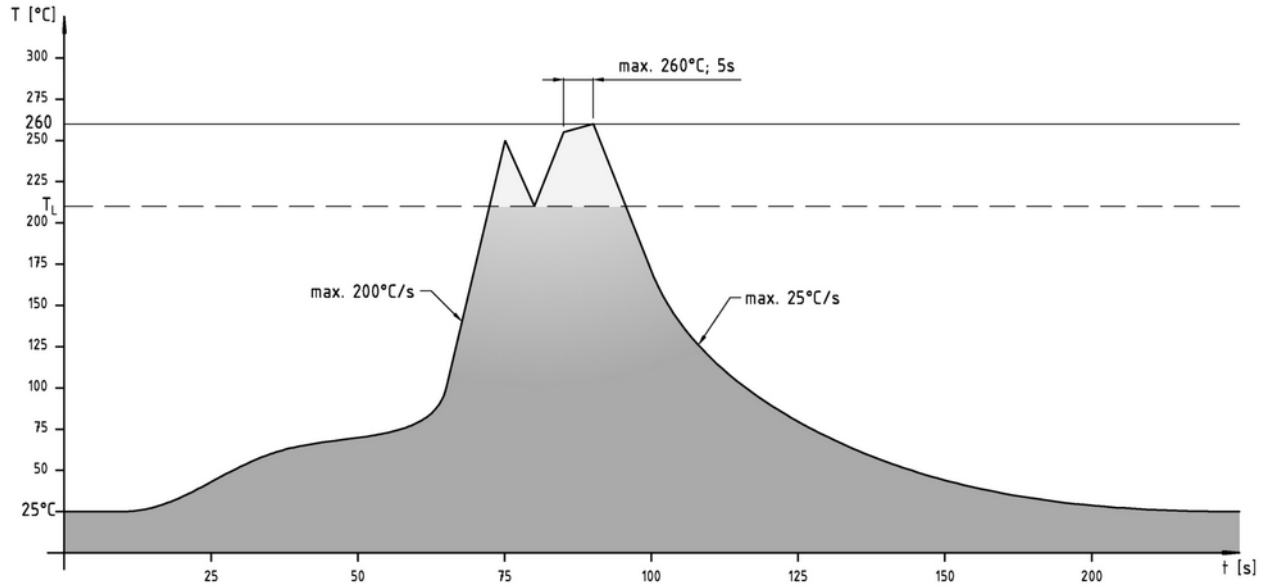

## Produktübersicht Modular Steckverbinder / Kabelkonfektionen Product Overview Modular Connectors / Cable Assemblies

### Single Port/Multi Port 658 / 6580

- Einlöt- oder SMT-Versionen
- 1 - 8 seitliche Eingänge
- auch mit LED-Signalleuchten in Farben gelb, grün, rot, bicolor
- voll geschirmt mit/ohne Erdungslasche

### Single Port/Multi Port 658 / 6580

- Solder-in oder SMT mounting
- 1 - 8 side entries
- LED optical indicators in colours yellow, green, red, bi-colour
- Fully shielded with optional ground latch

### Beschaltete Buchsen 655

- Single oder Multi Ports
- Gigabit Ethernet
- 10/100 Mbit Ethernet
- Übertragerschaltung und weitere Beschaltungen ...

### Jacks with built-in circuits 655

- Single or Multi Ports
- Gigabit Ethernet
- 10/100 Mbit Ethernet
- Transformer circuit and even more circuits ...

### M-Typ Top Entry 3018

- SMT-Technik
- Eingang von oben
- 6P6C / 8P8C

### M-Type Top Entry 3018

- SMT Connectors
- Top Entry
- 6P6C / 8P8C

### Weitere Varianten

- RJ-45 Keystone Jacks
- Up-Latch Varianten
- RJ-45 Combi Ports mit USB, eSata, ...
- Kabelkonfektionen
- Kundenspezifische Lösungen

### More Variations

- RJ-45 Keystone Jacks
- Up-Latch Versions
- RJ-45 Combi Ports with USB, eSata, ...
- Cable Assemblies
- Customized Solutions

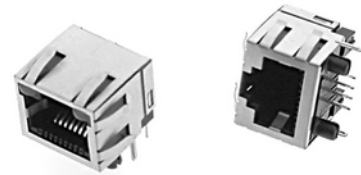

RJ-45 mit LED's, geschirmt  
RJ-45 with LED's, shielded

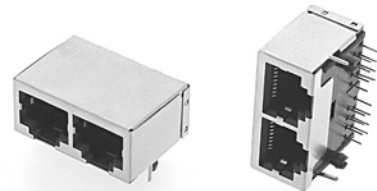

RJ-45 Multi Port  
RJ-45 Multi Port

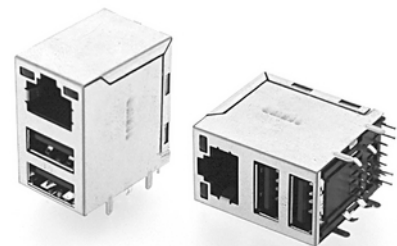

RJ-45 Combi Port  
RJ-45 Combi Port

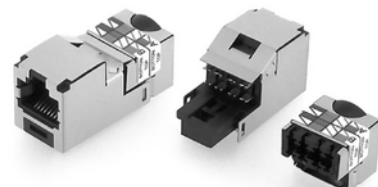

RJ-45 Keystone Jacks  
RJ45 Keystone Jacks



RJ-45 Kabelkonfektion  
RJ-45 Cable Assemblies