

# EtherCAT Network Adapter GN-9386 User Manual



REV 1.01

**2020 CREVIS Co., Ltd.**



## Contents

<b>1. Important Notes</b> .....	<b>5</b>
<b>1.1. Safety Instruction</b> .....	<b>6</b>
1.1.1. Symbols .....	6
1.1.2. Safety Notes .....	6
1.1.3. Certification .....	6
<b>2. Environment Specification</b> .....	<b>7</b>
<b>3. General Description</b> .....	<b>7</b>
<b>3.1. GN-9386 Specification</b> .....	<b>7</b>
<b>3.2. GN-9386 Wiring Diagram</b> .....	<b>9</b>
<b>3.3. GN-9386 LED Indicator</b> .....	<b>10</b>
3.3.1. LED Indicator .....	10
3.3.2. MOD(Module Status LED) .....	10
3.3.3. RUN(Current Running Status LED) .....	10
3.3.4. ERROR(Error State LED) .....	11
3.3.5. IOS LED(Extension Module Status LED) .....	11
3.3.6. Field Power, System Power LED(Field Power, System Power Status LED) .....	11
3.3.7. Indicator states and flash rates .....	12
<b>3.4. GN-9386 Electrical Interface</b> .....	<b>13</b>
3.4.1. RJ-45 Socket .....	13
3.4.2. DIP Switch .....	13
3.4.3. RS232 Port for MODBUS/RTU, Touch Panel or I/O Guide .....	14
<b>3.5. EtherCAT ID Type Setup</b> .....	<b>14</b>
3.5.1. Hot Connection On TwinCAT .....	14
<b>3.6. I/O Process Image Map</b> .....	<b>17</b>
3.6.1. Example of Input Process Image (Input Register) Map .....	18
3.6.2. Example of Output Process Image (Output Register) Map .....	19
<b>4. Dimension</b> .....	<b>21</b>
<b>4.1. GN-9386</b> .....	<b>21</b>
<b>5. EtherCAT Basics</b> .....	<b>22</b>
<b>5.1. EtherCAT Protocol</b> .....	<b>22</b>

5.2. EtherCAT State Machine .....	22
5.3. EtherCAT Mailbox.....	24
5.4. CoE Interface .....	26
5.4.1. Parameter management in the EtherCAT system.....	26
5.4.2. Communication Objects .....	27
6. MODBUS Interface .....	29
6.1. MODBUS Interface Register/Bit Map.....	29
6.2. Supported MODBUS Function Codes .....	30
6.2.1. 8 (0x08) Diagnostics .....	32
6.2.2. Error Response .....	33
6.3. MODBUS Special Register Map.....	34
6.3.1. Adapter Identification Special Register (0x1000, 4096).....	34
6.3.2. Adapter Information Special Register (0x1100, 4352).....	35
6.3.3. Expansion Slot Information Special Resister (0x2000, 8192).....	36
6.4. Supported MODBUS Function Codes .....	38
7. TROUBLE SHOOTING.....	39
APPENDIX A.....	41
A.1. Product List.....	41
A.2. Glossary .....	41

## 1. Important Notes

Solid state equipment has operational characteristics differing from those of electromechanical equipment. Safety Guidelines for the Application, Installation and Maintenance of Solid State Controls describes some important differences between solid state equipment and hard-wired electromechanical devices. Because of this difference, and also because of the wide variety of uses for solid state equipment, all persons responsible for applying this equipment must satisfy themselves that each intended application of this equipment is acceptable.

In no event will CREVIS be responsible or liable for indirect or consequential damages resulting from the use or application of this equipment.

The examples and diagrams in this manual are included solely for illustrative purposes. Because of the many variables and requirements associated with any particular installation, CREVIS cannot assume responsibility or liability for actual use based on the examples and diagrams.

### Warning!



- ✓ **If you don't follow the directions, it could cause a personal injury, damage to the equipment or explosion**
- Do not assemble the products and wire with power applied to the system. Else it may cause an electric arc, which can result into unexpected and potentially dangerous action by field devices. Arching is explosion risk in hazardous locations. Be sure that the area is non-hazardous or remove system power appropriately before assembling or wiring the modules.
- Do not touch any terminal blocks or IO modules when system is running. Else it may cause the unit to an electric shock or malfunction.
- Keep away from the strange metallic materials not related to the unit and wiring works should be controlled by the electric expert engineer. Else it may cause the unit to a fire, electric shock or malfunction.

### Caution!

- ✓ **If you disobey the instructions, there may be possibility of personal injury, damage to equipment or explosion. Please follow below Instructions.**
- Check the rated voltage and terminal array before wiring. Avoid the circumstances over 55°C of temperature. Avoid placing it directly in the sunlight.
- Avoid the place under circumstances over 85% of humidity.
- Do not place Modules near by the inflammable material. Else it may cause a fire.
- Do not permit any vibration approaching it directly.
- Go through module specification carefully, ensure inputs, output connections are made with the specifications. Use standard cables for wiring.
- Use Product under pollution degree 2 environment.

## 1.1. Safety Instruction

### 1.1.1. Symbols

<p><b>DANGER</b></p> 	<p>Identifies information about practices or circumstances that can cause an explosion in a hazardous environment, which may lead to personal injury or death property damage or economic loss.</p>
<p><b>IMPORTANT</b></p>	<p>Identifies information that is critical for successful application and understanding of the product.</p>
<p><b>ATTENTION</b></p> 	<p>Identifies information about practices or circumstances that can lead to personal injury, property damage, or economic loss. Attentions help you to identify a hazard, avoid a hazard, and recognize the consequences.</p>

### 1.1.2. Safety Notes

<p><b>DANGER</b></p> 	<p>The modules are equipped with electronic components that may be destroyed by electrostatic discharge. When handling the modules, ensure that the environment (persons, workplace and packing) is well grounded. Avoid touching conductive components, e.g. G-BUS Pin.</p>
--	--

### 1.1.3. Certification

c-UL-us UL Listed Industrial Control Equipment, certified for U.S. and Canada  
See UL File E235505

FCC, Reach, RoHS- II, China RoHS

CE Certificate

EN 61000-6-2; Industrial Immunity

EN 61000-6-4; Industrial Emissions

## 2. Environment Specification

Environment Specification	
Operating Temperature	-40 °C ~ 70 °C
UL Temperature	-20 °C ~ 60 °C
Storage Temperature	-40 °C ~ 85 °C
Relative Humidity	5% ~ 90% non-condensing
Mounting	DIN rail
General Specification	
Shock Operating	IEC 60068-2-27
Vibration resistance	Based on IEC 60068-2-6 DNVGL-CG-0039 : Vibration Class B, 4g
Industrial Emissions	EN 61000-6-4/A11 : 2011
Industrial Immunity	EN 61000-6-2 : 2005
Installation Position	Vertical and horizontal installation is available.
Product Certifications	CE, UL, FCC

## 3. General Description

### 3.1. GN-9386 Specification

Items	Specification
Communication Interface Specification	
Adapter Type	Slave Node (EtherCAT)
Max. Expansion Slot	63 slots
I/O Data Size	Max 128 bytes each slot
Max. Network Node	65,535
Baud Rate	100Mbps
Bus Connection	2 x RJ-45
Mac Address / IP Address	Not needed
Other Serial Port	RS232 for MODBUS/RTU, Touch Panel or I/O Guide(Crevis Software)
Serial Configuration (RS232)	Node : 1 (Fixed) Baud Rate : 115200 (Fixed) Data bit : 8 (Fixed) Parity bit : No parity (Fixed) Stop bit : 1 (Fixed)

Indicator	6 Status LEDs  1 Green/Red, Module Status (MOD) 1 Green, Network Status (RUN) 1 Red, Error Status (ERROR) 1 Green/Red Expansion I/O Module Status (IOS) 1 Green, System Power Status 1 Green, Field Power Status
Module Location	Starter module left side of G-Series system
Field Power Detection	About 14Vdc
<b>General Specification</b>	
UL System Power	Supply voltage : 24Vdc nominal, Class 2
System Power	Supply voltage : 24Vdc nominal Supply voltage range : 15~30Vdc Protection : Output current limit (Min. 1.5A) Reverse polarity protection
Power Dissipation	Max. 70mA @ 24Vdc
Current for I/O Module	1.5A @ 5Vdc
Isolation	System power to internal logic : Non-Isolation System power I/O driver : Isolation
UL Field Power	Supply voltage : 24Vdc nominal, Class 2
Field Power	Supply voltage : 24Vdc typical (Max. 30Vdc) * Field Power Range is different depending on IO Module series. Refer to IO Module`s Specification.
Wiring	I/O Cable Max. 2.0mm <sup>2</sup> (AWG 14)
Torque	0.8Nm(7 lb-in)
Weight	167g
Module Size	54mm x 99mm x 70mm
Environment Condition	Refer to '2. Environment Specification'



### 3.2. GN-9386 Wiring Diagram

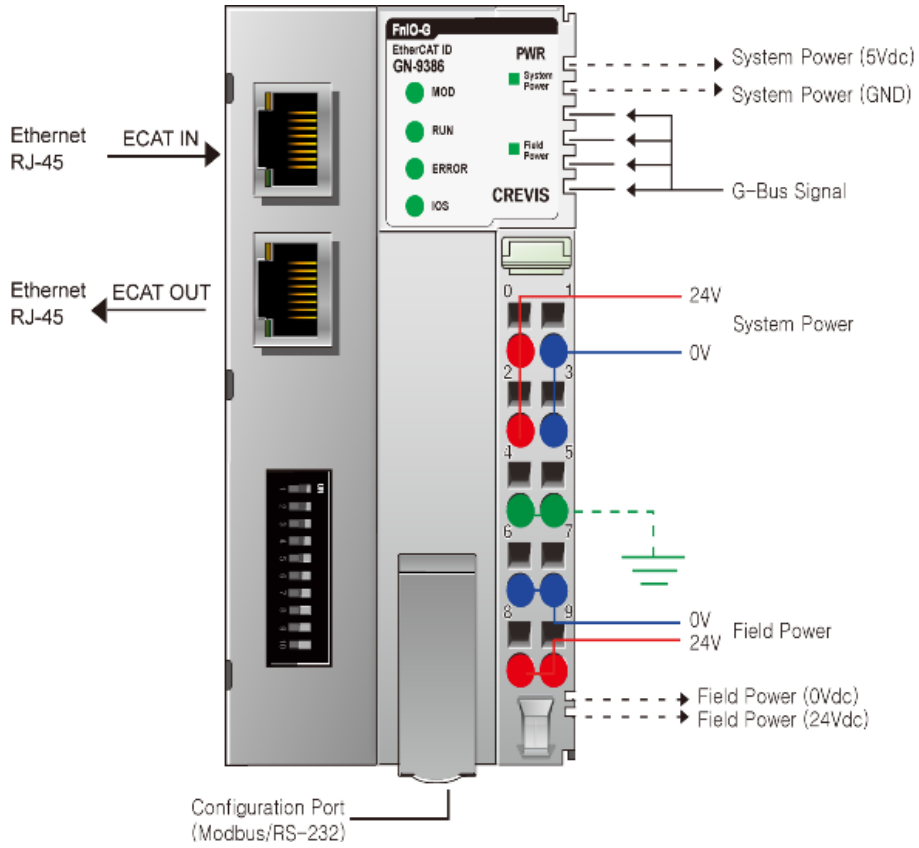

Pin No.	Signal Description	Signal Description	Pin No.
0	System Power, 24V	System Power, Ground	1
2	System Power, 24V	System Power, Ground	3
4	F.G	F.G	5
6	Field Power, Ground	Field Power, Ground	7
8	Field Power, 24V	Field Power, 24V	9

### 3.3. GN-9386 LED Indicator

#### 3.3.1. LED Indicator

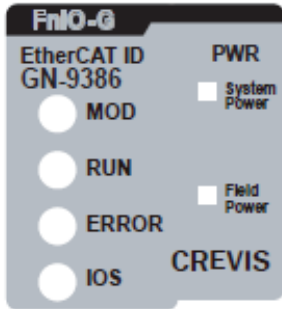

LED No.	LED Function / Description	LED Color
MOD	Module Status	Green/Red
RUN	Current Running Status	Green
ERROR	Error Status (EtherCAT)	Red
IOS	Extension Module Status	Green/Red
System Power	System Power Enable	Green
Field Power	Field Power Enable	Green

#### 3.3.2. MOD(Module Status LED)

Status	LED	To indicate
Not Powered	OFF	power is not supplied to the unit.
Normal, Operational	Green	The unit is operating in normal condition.
Device in Standby	Flashing Green	The EEPROM parameter is not initialized yet. Serial Number is zero value (0x00000000)
Minor Fault	Flashing Red	The unit has occurred recoverable fault in self-testing. - EEPROM checksum fault.
Unrecoverable Fault	Red	The unit has occurred unrecoverable fault in self-testing. - Firmware fault

#### 3.3.3. RUN(Current Running Status LED)

Status	LED	To indicate
Init	OFF	State of the EtherCAT State Machine: INIT = Initialization.
Pre-Operation	Blinking	State of the EtherCAT State Machine: PREOP = Pre-Operation.
Safe-Operation	Single Flash	State of the EtherCAT State Machine: SAFEOP = Safe-Operation.
Initialization or Bootstrap	Flashes	State of the EtherCAT State Machine: BOOT = Bootstrap (Update of the coupler firmware)
Operational	ON	State of the EtherCAT State Machine: Operational.

### 3.3.4. ERROR(Error State LED)

Status	LED	To indicate
No Error	OFF	No Error.
Invalid Configuration	Blinking	Invalid Configuration.

### 3.3.5. IOS LED(Extension Module Status LED)

Status	LED	To indicate
Not Powered	OFF	Device has no expansion module or may not be powered.
Internal Bus On-line, Do not Exchanging I/O	Flashing Green	Internal Bus is normal but does not exchanging I/O data. (Passed the expansion module configuration)
Internal Bus Connection, Run Exchanging I/O	Green	Exchanging I/O data.
Internal Bus Connection Fault during Exchanging I/O	Red	One or more expansion module occurred in fault state. - Changed expansion module configuration. - Internal Bus communication failure. - Mismatch vendor code between adapter and expansion module.
Expansion Configuration Failed	Flashing Red	Failed to initialize expansion module. - Detect invalid expansion module ID. - Overflow Input/Output size. - No expansion module. - Too many expansion module. - Initial protocol failure.

### 3.3.6. Field Power, System Power LED(Field Power, System Power Status LED)

Status	LED	To indicate
Not supplied field, system power	OFF	Not supplied 24Vdc field power, 5Vdc system power.
Supplied field, system power	Green	Supplied 24Vdc field power, 5Vdc system power.

### 3.3.7. Indicator states and flash rates

LED ON	Constantly ON
LED OFF	Constantly OFF.
LED flickering	Equal ON and OFF times with a frequency of approximately 10 Hz: ON for approximately 50ms and OFF for approximately 50ms.
LED blinking	Equal ON and OFF times with a frequency of approximately 2, 5Hz: ON for approximately 200ms followed by OFF for approximately 200ms.
LED single flash	One short flash (approximately 200ms) followed by a long OFF phase (approximately 1000ms)
LED double flash	A sequence of two short flashes (approximately 200ms), separated by an OFF phase (approximately 200ms). The sequence is finished by a long OFF phase (approximately 1000ms)
LED triple flash	A sequence of three short flashes (approximately 200ms), separated by an OFF phase (approximately 200ms). The sequence is finished by a long OFF phase (approximately 1000ms)

### 3.4. GN-9386 Electrical Interface

#### 3.4.1. RJ-45 Socket

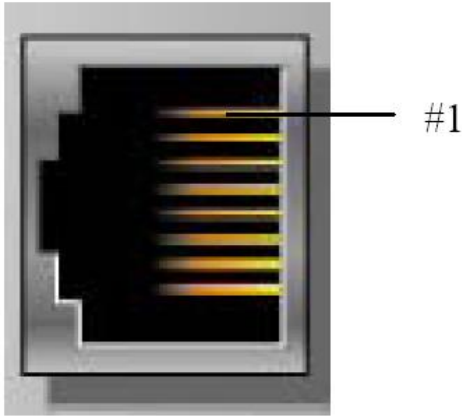

Shielded RJ-45 Socket

RJ-45	Signal Name	Description
1	TD+	Transmit +
2	TD-	Transmit -
3	RD+	Receive +
4	-	
5	-	
6	RD-	Receive -
7	-	
8	-	
Case	Shield	

#### 3.4.2. DIP Switch

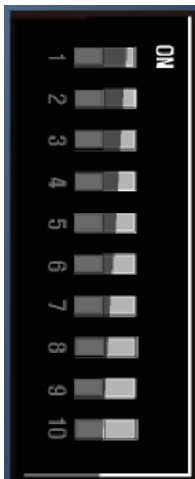

DIP Pole#	Description
1	IdentificationValue DIP bit#0
2	IdentificationValue DIP bit#1
3	IdentificationValue DIP bit#2
4	IdentificationValue DIP bit#3
5	IdentificationValue DIP bit#4
6	IdentificationValue DIP bit#5
7	IdentificationValue DIP bit#6
8	IdentificationValue DIP bit#7
9	Not Used
10	Not Used

### 3.4.3. RS232 Port for MODBUS/RTU, Touch Panel or I/O Guide

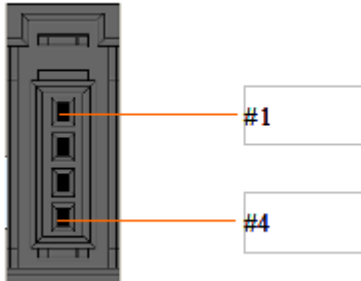

Pin#	Signal Name	Description
1	Reserved	----
2	TXD	RS232 TXD
3	RXD	RS232 RXD
4	GND	RS232 GND

## 3.5. EtherCAT ID Type Setup

### 3.5.1. Hot Connection On TwinCAT

Hot connection function can be used to remove a node from a preconfigured Configuration or change the location of nodes and flexible. This feature is available only Ethercat ID Type in TwinCAT. The user can use the external Dip Switch settings of the Adapter Identification Value.

For an example of using an external Dip Switch ( Refer to 2.4.2. )

Ex) node 1 (Min)



Ex) node 255 (Max)



## Hot Connection setting procedure

1. Add the EtherCAT ID Type in TwinCAT.

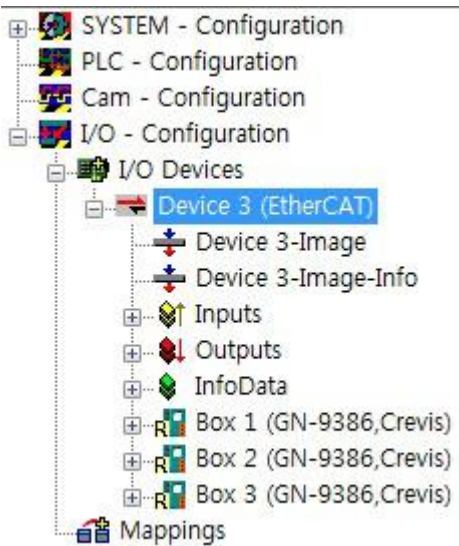

2. Hot Connect Group settings

Set the identification value same as dip-switch.

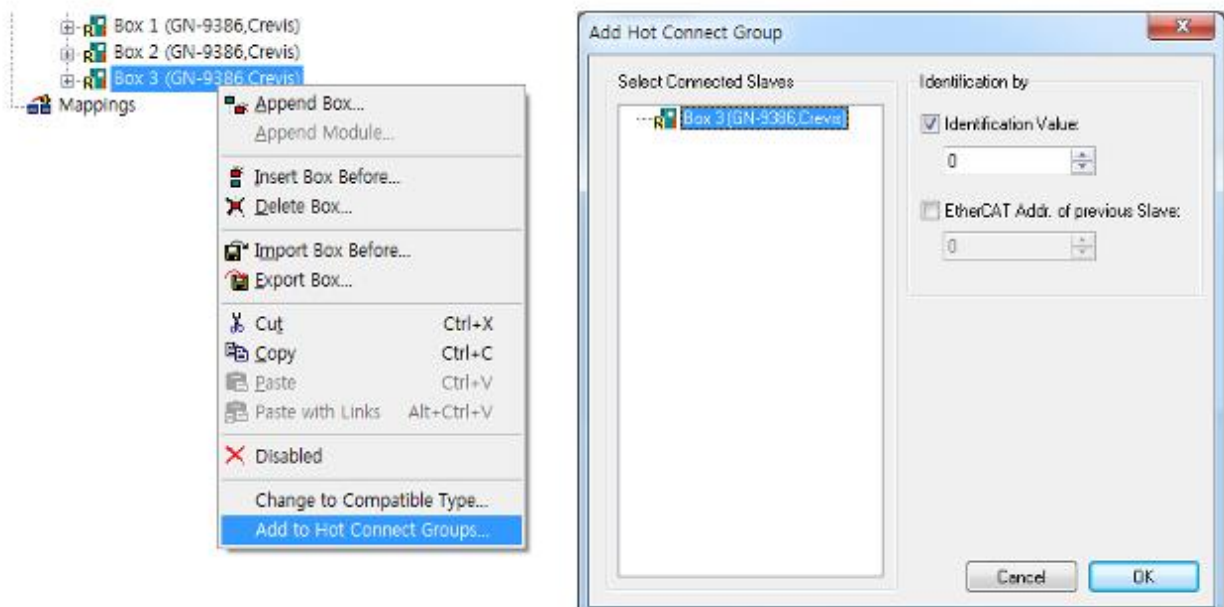

3. Hot connection group set up is completed, run the Reload I/O device(F4).

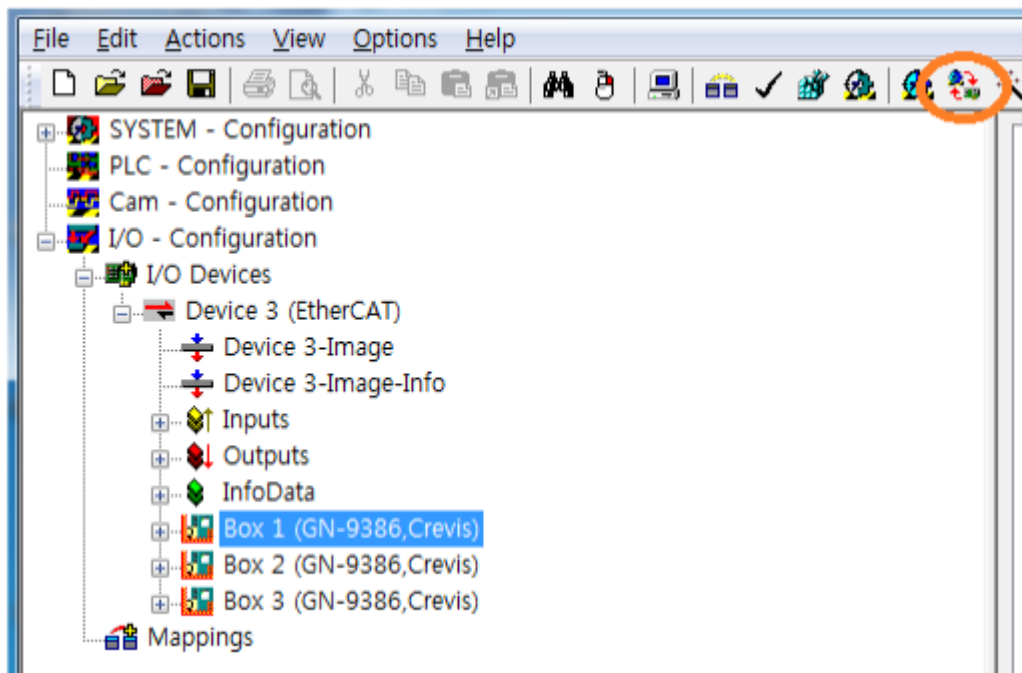

4. Now you can use the Hot connection feature.

Node is not overlapped between products. If there are same nodes, It should be changed.



### 3.6. I/O Process Image Map

An expansion module may have 3 types of data as I/O data, configuration parameter and memory register. The data exchange between network adapter and expansion modules is done via an I/O process image data by G-Series protocol. The following figure shows the data flow of process image between network adapter and expansion modules.

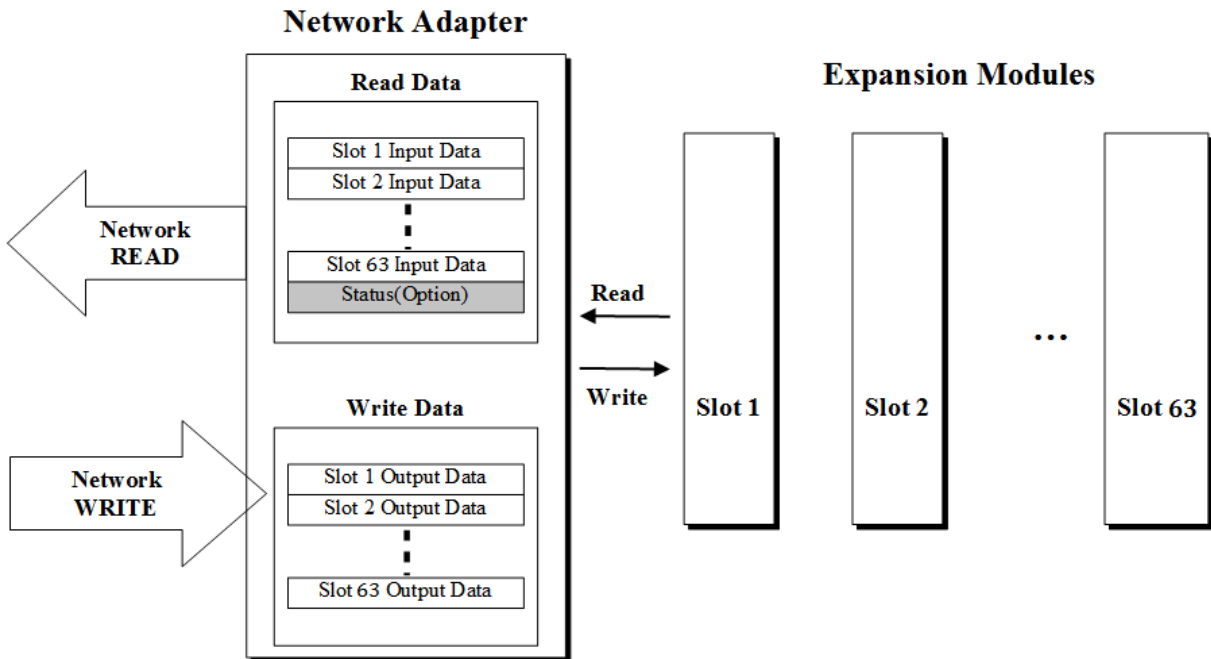

### 3.6.1. Example of Input Process Image (Input Register) Map

Input image data depends on slot position and expansion slot data type. Input process image data is only ordered by expansion slot position.

For example slot configuration

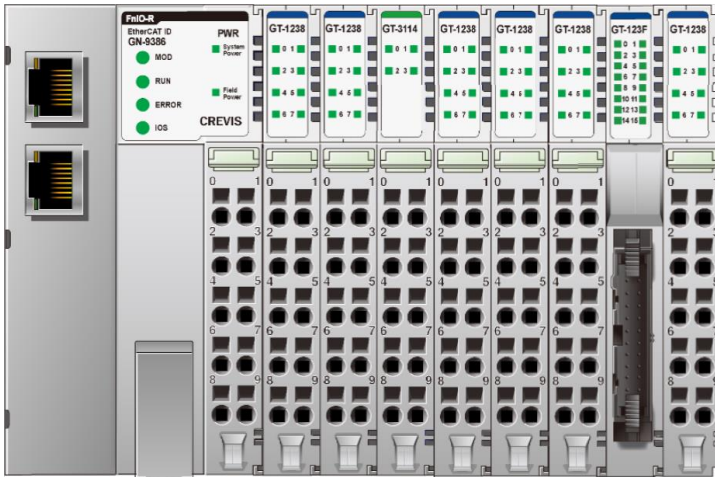

Slot Address	Module Description
#0	EtherCAT Adapter
#1	8-discrete input
#2	8-discrete input
#3	4-analog input
#4	8-discrete input
#5	8-discrete input
#6	8-discrete input
#7	16-discrete input
#8	8-discrete input

- Input Process Image

TXPDO	Entries	Byte	Bit 7	Bit 6	Bit 5	Bit 4	Bit 3	Bit 2	Bit 1	Bit 0
0x1A01	0x6010	0	Discrete Input 8 pts (Slot#1)							
0x1A02	0x6020	1	Discrete Input 8 pts (Slot#2)							
0x1A03	0x6030	2	Analog Input Ch0 low byte (Slot#3)							
		3	Analog Input Ch0 high byte (Slot#3)							
		4	Analog Input Ch1 low byte (Slot#3)							
		5	Analog Input Ch1 high byte (Slot#3)							
		6	Analog Input Ch2 low byte (Slot#3)							
		7	Analog Input Ch2 high byte (Slot#3)							
		8	Analog Input Ch3 low byte (Slot#3)							
		9	Analog Input Ch3 high byte (Slot#3)							
0x1A04	0x6040	10	Discrete Input 8 pts (Slot#4)							
0x1A05	0x6050	11	Discrete Input 8 pts (Slot#5)							
0x1A06	0x6060	12	Discrete Input 8 pts (Slot#6)							
0x1A07	0x6070	13	Discrete Input 8 pts (Slot#7)							
		14	Discrete Input 8 pts (Slot#7)							
0x1A08	0x6080	15	Discrete Input 8 pts (Slot#8)							

### 3.6.2. Example of Output Process Image (Output Register) Map

Output image data depends on slot position and expansion slot data type. Output process image data is only ordered by expansion slot position.

For example slot configuration

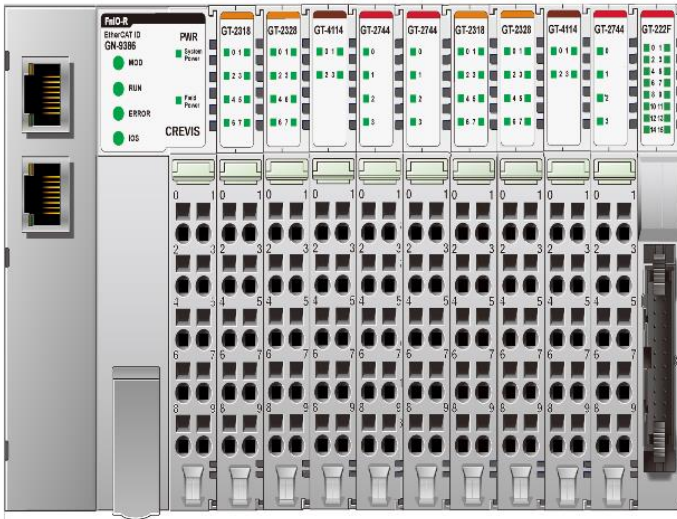

Slot Address	Module Description
#0	EtherCAT Adapter
#1	8-discrete output
#2	8-discrete output
#3	4-analog output
#4	4- relay output
#5	4-relay output
#6	8-discrete output
#7	8-discrete output
#8	4-analog output
#9	4-relay output
#10	16-discrete output

- Output Process Image

RXPDO	Entries	Byte	Bit 7	Bit 6	Bit 5	Bit 4	Bit 3	Bit 2	Bit 1	Bit 0
0x1601	0x7010	0	Discrete Output 8 pts (Slot#1)							
0x1602	0x7020	1	Discrete Output 8 pts (Slot#2)							
0x1603	0x7030	2	Analog Output Ch0 low byte (Slot#3)							
		3	Analog Output Ch0 high byte (Slot#3)							
		4	Analog Output Ch1 low byte (Slot#3)							
		5	Analog Output Ch1 high byte (Slot#3)							
		6	Analog Output Ch2 low byte (Slot#3)							
		7	Analog Output Ch2 high byte (Slot#3)							
		8	Analog Output Ch3 low byte (Slot#3)							
		9	Analog Output Ch3 high byte (Slot#3)							
0x1604	0x7040	10	Discrete Output low 4 pts (Slot#4)							
0x1605	0x7050	12	Discrete Output low 4 pts (Slot#5)							
0x1606	0x7060	13	Discrete Output low 8 pts (Slot#6)							
0x1607	0x7070	14	Discrete Output low 8 pts (Slot#7)							

0x1608	0x7080	15	Analog Output Ch0 low byte (Slot#8)
		16	Analog Output Ch0 high byte (Slot#8)
		17	Analog Output Ch1 low byte (Slot#8)
		18	Analog Output Ch1 high byte (Slot#8)
		19	Analog Output Ch2 low byte (Slot#8)
		20	Analog Output Ch2 high byte (Slot#8)
		21	Analog Output Ch3 low byte (Slot#8)
		22	Analog Output Ch3 high byte (Slot#8)
0x1609	0x7090	24	Discrete Output low 8 pts (Slot#9)
0x160A	0x70A0	25	Discrete Output low 8 pts (Slot#10)
		26	Discrete Output high 8 pts (Slot#10)

## 4. Dimension

### 4.1. GN-9386

(mm)

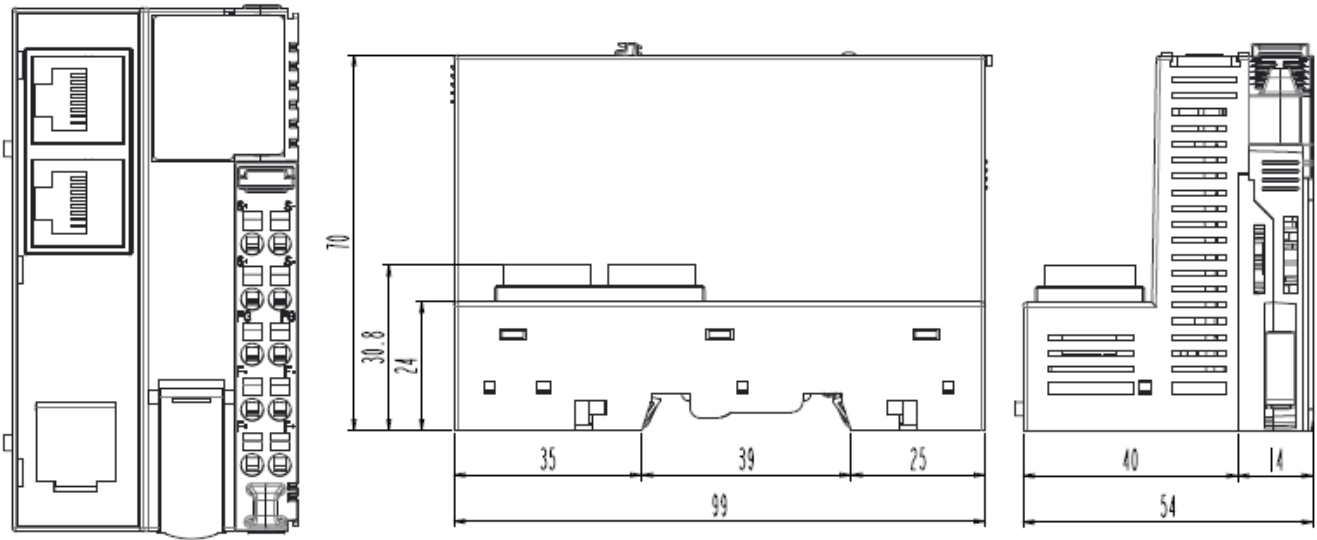

## 5. EtherCAT Basics

The EtherCAT protocol uses an officially assigned EtherType inside the Ethernet Frame. The use of this EtherType allows transport of control data directly within the Ethernet frame without redefining the standard Ethernet frame. The frame may consist of several sub-telegrams, each serving a particular memory area of the logical process images that can be up to 4 gigabytes in size. Addressing of the Ethernet terminals can be in any order because the data sequence is independent of the physical order. Broadcast, Multi-cast and communication between slaves are possible.

### 5.1. EtherCAT Protocol

The EtherCAT protocol uses an officially assigned EtherType inside the Ethernet Frame. The use of this EtherType allows transport of control data directly within the Ethernet frame without redefining the standard Ethernet frame. The frame may consist of several sub-telegrams, each serving a particular memory area of the logical process images that can be up to 4 gigabytes in size. Addressing of the Ethernet terminals can be in any order because the data sequence is independent of the physical order. Broadcast, Multicast and communication between slaves are possible.

### 5.2. EtherCAT State Machine

The state of the EtherCAT slave is controlled via the EtherCAT State Machine (ESM). Depending upon the state, different functions are accessible or executable in the EtherCAT slave. Specific commands must be sent by the EtherCAT master to the device in each state, particularly during the boot up of the slave.

A distinction is made between the following states:

- Init
- Pre-Operational
- Safe-Operational and
- Operational
- Bootstrap

The regular state of each EtherCAT slave after bootup is the OP state.

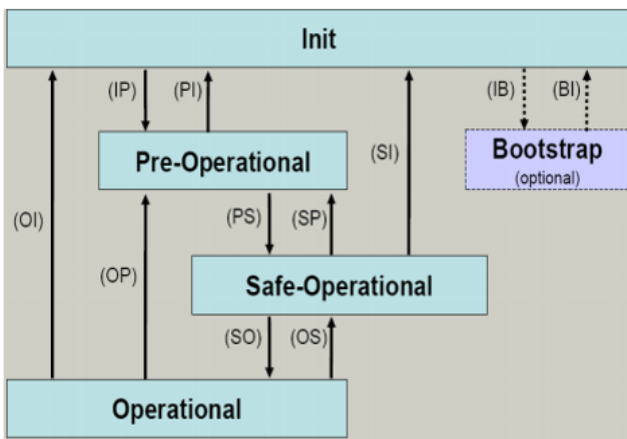

**Init**

After switch-on the EtherCAT slave in the Init state. No mailbox or process data communication is possible. The EtherCAT master initializes sync manager channels 0 and 1 for mailbox communication.

**Pre-Operational (Pre-Op)**

During the transition between Init and Pre-Op the EtherCAT slave checks whether the mailbox was initialized correctly.

In Pre-Op state mailbox communication is possible, but not process data communication. The EtherCAT master initializes the sync manager channels for process data (from sync manager channel 2), the FMMU channels and, if the slave supports configurable mapping, PDO mapping or the sync manager PDO assignment. In this state the settings for the process data transfer and perhaps terminal-specific parameters that may differ from the default settings are also transferred.

**Safe-Operational (Safe-Op)**

During transition between Pre-Op and Safe-Op the EtherCAT slave checks whether the sync manager channels for process data communication and, if required, the distributed clocks settings are correct. Before it acknowledges the change of state, the EtherCAT slave copies current input data into the associated DP-RAM areas of the EtherCAT slave controller (ECSC).

In Safe-Op state mailbox and process data communication is possible, although the slave keeps its outputs in a safe state, while the input data are updated cyclically.

**Operational (Op)**

Before the EtherCAT master switches the EtherCAT slave from Safe-Op to Op it must transfer valid output data.

In the Op state the slave copies the output data of the masters to its outputs. Process data and mailbox communication is possible.

**Bootstrap**

In the Boot state the slave firmware can be updated. The Boot state can only be reached via the Init state.

In the Boot state mailbox communication via the file access over EtherCAT (FoE) protocol is possible, but no other mailbox communication and no process data communication.

### 5.3. EtherCAT Mailbox

The device profiles describe the application parameters and the functional behavior of the devices including the device class-specific state machines. For many device classes, fieldbus technology already offers reliable device profiles, for example for I/O devices, drives or valves. Users are familiar with these profiles and the associated parameters and tools. No EtherCAT-specific device profiles have therefore been developed for these device classes. Instead, simple interfaces for existing device profiles are being offered (see Fig. 1). This greatly assists users and device manufacturers alike during the migration from the existing fieldbus to EtherCAT. At the same time the EtherCAT specification keeps it simple because all the protocols are optional. The device manufacturer only has to implement the protocol that the device application needs.

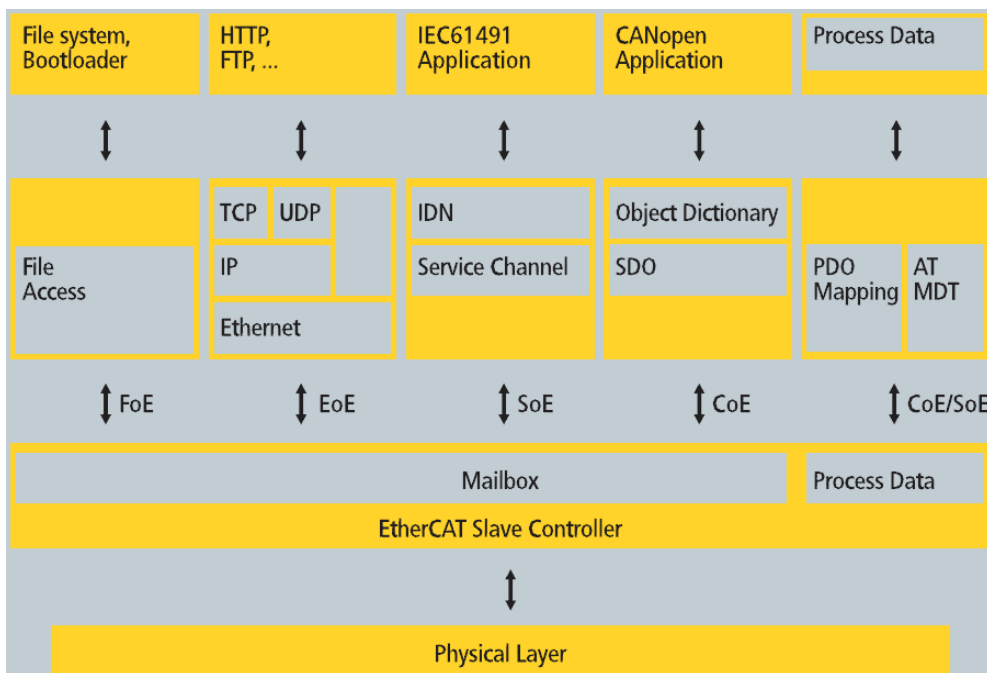

<Fig. 1> Several Device Profiles and Protocols can co-exist side by side

- **CAN application layer over EtherCAT (CoE)**

CANopen® device and application profiles are available for a wide range of device classes and applications, ranging from I/O components, drives, encoders, proportional valves and hydraulic controllers to application profiles for plastic or textile machinery, for example. EtherCAT can provide the same communication mechanisms as the familiar CANopen [1] mechanisms: object dictionary, PDO (process data objects) and SDO (service data objects) – even the network management is comparable. EtherCAT can thus be implemented with minimum effort on devices equipped with CANopen. Large parts of the CANopen firmware can be reused. Objects can optionally be expanded in order to account for the larger bandwidth offered by EtherCAT.



- **Servo drive profile according to IEC 61800-7-204(SERCOS) (SoE)**

SERCOS interface™ is acknowledged as a high-performance real-time communication interface, particularly for motion control applications. The SERCOS profile for servo drives and the communication technology are covered by the IEC 61800-7-204 standard. The mapping of this profile to EtherCAT (SoE) is specified in part 304 [2]. The service channel, and therefore access to all parameters and functions residing in the drive, is based on the EtherCAT mailbox.

Here too, the focus is on compatibility with the existing protocol (access to value, attribute, name, units, etc. of the IDNs) and expandability with regard to data length limitation. The process data, with SERCOS in the form of AT and MDT data, are transferred using EtherCAT device protocol mechanisms. The mapping is similar to the SERCOS mapping. The EtherCAT slave state machine can also be mapped easily to the phases of the SERCOS protocol. EtherCAT provides advanced real-time Ethernet technology for this device profile, which is particularly widespread in CNC applications. Optionally, the command position, speed or torque can be transferred. Depending on the implementation, it is even possible to continue using the same configuration tools for the drives.

- **Ethernet over EtherCAT (EoE)**

The EtherCAT technology is not only fully Ethernet-compatible, but also characterized by particular openness “by design”: the protocol tolerates other Ethernet-based services and protocols on the same physical network – usually even with minimum loss of performance. There is no restriction on the type of Ethernet device that can be connected within the EtherCAT segment via a switchport.

The Ethernet frames are tunneled via the EtherCAT protocol, which is the standard approach for internet applications(e.g. VPN, PPPoE (DSL), etc.). The EtherCAT network is fully transparent for the Ethernet device, and the real-time characteristics are not impaired (see Fig. 2).

The master acts like a layer 2 switch that redirects the frames to the respective devices according to the address

information. All internet technologies can therefore also be used in the EtherCAT environment: integrated web server, e-mail, FTP transfer, etc.

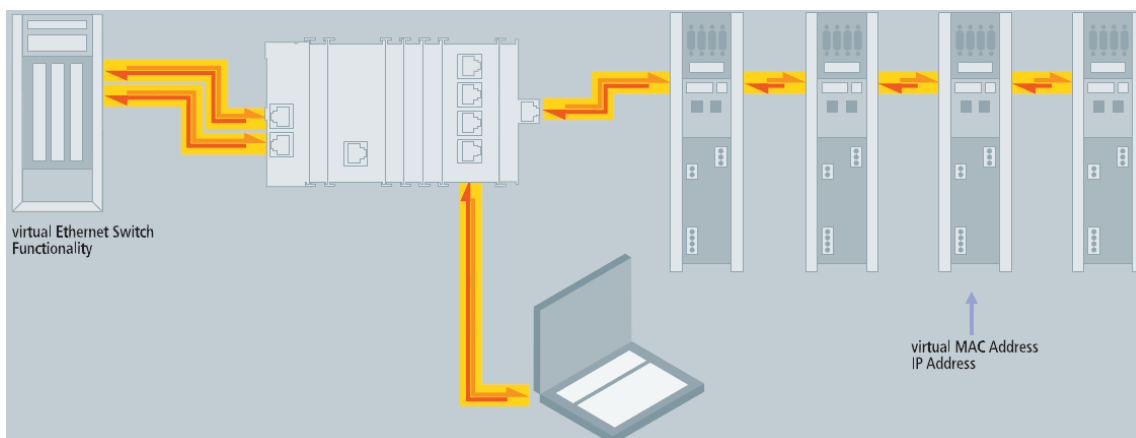

<Fig. 2> Transparent for all Ethernet Protocols

- **File Access over EtherCAT (FoE)**

any data structure in the device. Standardized firmware upload to devices is therefore possible, irrespective of whether or not they support TCP/IP.

➤ **Literature**

[1] EN 50325-4: Industrial communications subsystem based on ISO 11898 (CAN) for controller-device interfaces. Part 4: CANopen.

[2] IEC 61800-7-301/304, Adjustable speed electrical power drive systems – Part 7-301: Generic interface and use

of profiles for power drive systems – Mapping of profile type 1 to network technologies – Part 7-304: Generic interface and use of profiles for power drive systems – Mapping of profile type 4 to network technologies

## 5.4. CoE Interface

### 5.4.1. Parameter management in the EtherCAT system

The CiA organization (CAN in Automation) pursues among other things the goal of creating order and exchange ability between devices of the same type by the standardization of device descriptions. For this purpose so-called profiles are defined, which conclusively describe the changeable and unchangeable parameters of a device. Such a parameter encompasses at least the following characteristics:

- Index number – for the unambiguous identification of all parameters. The index number is divided into a main index and a subindex in order to mark and arrange associated parameters.
  - Main index
  - Subindex, offset by a colon ':'
- Official name – in the form of an understandable, self-descriptive text
- Specification of changeability, e.g. whether it can only be read or can also be written
- A value – depending upon the parameter the value can be a text, a number or another parameter index.

#### Index Range

The relevant ranges for EtherCAT fieldbus users are:

**x1000** : This is where fixed identity information for the device is stored, including name, manufacturer, serial number etc., plus information about the current and available process data configurations.

**x8000** : This is where the operational and functional parameters for all channels are stored, such as filter settings or output frequency.

Other important ranges are:

**x4000** : In some EtherCAT devices the channel parameters are stored here (as an alternative to the x8000 range).

**x6000** : Input PDOs ("input" from the perspective of the EtherCAT master)

**x7000** : Output PDOs ("output" from the perspective of the EtherCAT master)

## 5.4.2. Communication Objects

Index	Sub-index	Name	Flags	Default value
1000		Device type	RO	0x00001389
1001		Gbus Status	RO	Normal Operation : 0x00 **
1002		Master Fault Aaction	RW	0x00
1008		Device name	RO	GN-9386(Crevis)
1009		Hardware version	RO	GN-9386.v1
100A		Software version	RO	1.000
1018		Identity	RO	0x05
	01	Vendor ID (Crevis: 029D)	RO	0x0000029D
	02	Product code	RO	0x4E419386
	03	Revision	RO	0x0001000
	04*	Serial number	RO	0xFFFFFFFF
	05	Release date	RO	0x20160823
10F1		Error Settings	RO	0x02
	01	Local Error Reaction	RO	0x00000000
	02	Sync Error Counter Limit	RO	0x00000004
1601*		Slot#x, GT--xxxx,RXPDO	RO	0xnn
	01	SubIndex 001	RO	0x7010:01, 8
	...	...	...	...
	nn	SubIndex nnn	RO	0x7010:nn, 8
1A01*		Slot#x, GT-xxxx, TXPDO	RO	0xnn
	01	SubIndex 001	RO	0x6010:01, 8
	...	...	...	...
	nn	SubIndex nnn	RO	0x6010:nn, 8
1C00		Sync manager type	RO	0x04
	01	SubIndex 001	RO	0x01
	02	SubIndex 002	RO	0x02
	03	SubIndex 003	RO	0x03
	04	SubIndex 004	RO	0x04
1C12		RxPDO assign	RO	0x01
	01	SubIndex 001	RO	0x1601
1C13		TxPDO assign	RO	0x02
	01	SubIndex 001	RO	0x1A01
	02	SubIndex 002	RO	0x1A02

7010*	GT-xxxx		RO	0xnn
	01	Byte#0	RW P	0x00
	...	...	...	...
	nn	Byte#nnn	RW P	0x00
8000	GN-9386(Parameter)		RO	
	01	Byte#0	RW	
	02	Byte#1	RW	
	03	Byte#2	RW	
	04	Byte#3	RW	
8nn0*	GT-xxxx(Parameter)		RO	
	01	Byte#0	RW	
	...	...	...	...
	nn	Byte#nnn	RW	
F000	Module device profile		RO	
	01	Module index distance	RO	
	02	Maximum numver of modules	RO	
F010*	Module List		RO	
	01	Subindex 001 (GN-9386)	RO	0x00009386
	...	...	...	...
	63	Subindex 063	RO	0x0000xxxx
F050	Detected Module Ident List		RO	
	01...	SubIndex 001	RO	

\*This value can be changed depending on the configuration of expansion modules

\*\* G-BUS Status

- Normal Operation : 0x00
- Communication Fault : 0x02
- Configuration Failed : 0x03
- No Expansion Module : 0x04
- Vendor Error : 0x07
- Not expected slot : 0x08
- CRC Error : 0x09

## 6. MODBUS Interface

### 6.1. MODBUS Interface Register/Bit Map

- Register Map

Start Address	Read/Write	Description	Func. Code
0x0000 ~	Read	Process input image registers (Real Input Register)	3,4,23
0x0800 ~	Read/Write	Process output image registers (Real Output Register)	3,16,23
0x1000 *	Read	Adapter Identification special registers.	3,4,23
0x1020 *	Read/Write	Adapter Watchdog, other time special register.	3,4,6,16,23
0x1100 *	Read/Write	Adapter Information special registers.	3,4,6,16,23
0x2000 *	Read/Write	Expansion Slot Information special registers.	3,4,6,16,23

\* The special register map must be accessed by read/write of every each address (one address).

- Register Map

Start Address	Read/Write	Description	Func. Code
0x0000~	Read	Process input image bits All input registers area are addressable by bit address. Size of input image bit is size of input image register * 16.	2
0x1000~	Read/Write	Process output image bits All output registers area are addressable by bit address. Size of output image bit is size of output image register * 16.	1,5,15

## 6.2. Supported MODBUS Function Codes

Function Code	Function	Description
1(0x01)	Read Coils (Read output bit)	This function code is used to read from 1 to 2000 contiguous status of coils in a remote device. The Request PDU specifies the starting address, i.e. the address of the first coil specified, and the number of coils. In the PDU Coils are addressed starting at zero. Therefore coils numbered 1-16 are addressed as 0-15. The coils in the response message are packed as one coil per bit of the data field. Status is indicated as 1= ON and 0= OFF.
2(0x02)	Read Discrete Inputs (Read input bit)	This function code is used to read from 1 to 2000 contiguous status of discrete inputs in a remote device. The Request PDU specifies the starting address, i.e. the address of the first input specified, and the number of inputs. In the PDU Discrete Inputs are addressed starting at zero. Therefore Discrete inputs numbered 1-16 are addressed as 0-15. The discrete inputs in the response message are packed as one input per bit of the data field. Status is indicated as 1= ON; 0= OFF.
3(0x03)	Read Holding Registers (Read output word)	This function code is used to read the contents of a contiguous block of holding registers in a remote device. The Request PDU specifies the starting register address and the number of registers. The register data in the response message are packed as two bytes per register, with the binary contents right justified within each byte. For each register, the first byte contains the high order bits and the second contains the low order bits.
4(0x04)	Read Input Registers (Read input word)	This function code is used to read from 1 to approx. 125 contiguous input registers in a remote device. The Request PDU specifies the starting register address and the number of registers. The register data in the response message are packed as two bytes per register, with the binary contents right justified within each byte. For each register, the first byte contains the high order bits and the second contains the low order bits.
5(0x05)	Write Single Coil (Write one bit output)	This function code is used to write a single output to either ON or OFF in a remote device. The requested ON/OFF state is specified by a constant in the request data field. A value of FF 00 hex requests the output to be ON. A value of 00 00 requests it to be OFF. All other values are illegal and will not affect the output.

6(0x06)	Write Single Register (Write one word output)	This function code is used to write a single holding register in a remote device. Therefore register numbered 1 is addressed as 0. The normal response is an echo of the request, returned after the register contents have been written.
8(0x08)	Diagnostics (Read diagnostic register)  *Refer to the 4.2.1	MODBUS function code 08 provides a series of tests for checking the communication system between a client ( Master) device and a server ( Slave), or for checking various internal error conditions within a server. The function uses a two-byte sub-function code field in the query to define the type of test to be performed. The server echoes both the function code and sub-function code in a normal response. Some of the diagnostics cause data to be returned from the remote device in the data field of a normal response.
15(0x0F)	Write Multiple Coils (Write a number of output bits)	This function code is used to force each coil in a sequence of coils to either ON or OFF in a remote device. The Request PDU specifies the coil references to be forced. Coils are addressed starting at zero. A logical '1' in a bit position of the field requests the corresponding output to be ON. A logical '0' requests it to be OFF. The normal response returns the function code, starting address, and quantity of coils forced.
16(0x10)	Write Multiple registers (Write a number of output words)	This function code is used to write a block of contiguous registers (1 to approx. 120 registers) in a remote device. The requested written values are specified in the request data field. Data is packed as two bytes per register. The normal response returns the function code, starting address, and quantity of registers written.
23(0x17)	Read/Write Multiple registers (Read a number of input words /Write a number of output words)	Read a number of input words /Write a number of output words This function code performs a combination of one read operation and one write operation in a single MODBUS transaction. The write operation is performed before the read. The request specifies the starting address and number of holding registers to be read as well as the starting address, number of holding registers, and the data to be written. The byte count specifies the number of bytes to follow in the write data field. The normal response contains the data from the group of registers that were read. The byte count field specifies the quantity of bytes to follow in the read data field.

- Refer to MODBUS APPLICATION PROTOCOL SPECIFICATION V1.1a

## 6.2.1. 8 (0x08) Diagnostics

### Sub-function 0x0000(0) Return Query Data

The data passed in the request data field is to be returned (looped back) in the response.

The entire response message should be identical to the request.

Sub-function	Data Field (Request)	Data Field (Response)	Description
0x0000(0)	Any	Echo Request Data	

### Sub-function 0x0001(1) Restart Communications Option

The remote device could be initialized and restarted, and all of its communications event counters are cleared.

Especially, data field 0x55AA make the remote device to restart with factory default setup of EEPROM.

Sub-function	Data Field (Request)	Data Field (Response)	Description
0x0001(1)	0x0000 or 0xFF00	Echo Request Data	Reset
0x0001(1)	0x55AA+0xAA55+Sumcheck	Echo Request Data	Reset with Factory

### Sub-function 0x000B(11) Return Bus Message Count

The response data field returns the quantity of messages that the remote device has detected on the communications system since its last restart, clear counters operation, or power-up.

Sub-function	Data Field (Request)	Data Field (Response)	Description
0x000B(11)	0x0000	Total Message Count	

### Sub-function 0x000C(12) Return Bus Communication Error Count

The response data field returns the quantity of CRC errors encountered by the remote device since its last restart, clear counters operation, or power-up.

Sub-function	Data Field (Request)	Data Field (Response)	Description
0x000C(11)	0x0000	CRC Error Count	

### Sub-function 0x000D(13) Return Bus Exception Error Count

The response data field returns the quantity of MODBUS exception responses returned by the remote device since its last restart, clear counters operation, or power-up.

Exception responses are described and listed in section 3.2.11.

Sub-function	Data Field (Request)	Data Field (Response)	Description
0x000D(13)	0x0000	Exception Error Count	

### Sub-function 0x000E(14) Return Slave Message Count

The response data field returns the quantity of messages addressed to the remote device, or broadcast, that the remote device has processed since its last restart, clear counters operation, or power-up.

Sub-function	Data Field (Request)	Data Field (Response)	Description
0x000E(14)	0x0000	Slave Message Count	



**Sub-function 0x000F(15) Return Slave No Response Count**

The response data field returns the quantity of messages addressed to the remote device for which it has returned no response (neither a normal response nor an exception response), since its last restart, clear counters operation, or power-up.

Sub-function	Data Field (Request)	Data Field (Response)	Description
0x000F(15)	0x0000	Slave No Response Count	

**Sub-function 0x0064(100) Return Slave ModBus, G-Series internal bus Status**

The response data field returns the status of ModBus and Internal Bus addressed to the remote device. This status values are identical with status 1word of input process image. Refer to 2.4.2.

Sub-function	Data Field (Request)	Data Field (Response)	Description
0x0064(100)	0x0000	ModBus, Internal Bus Status	Same as status 1word

**6.2.2. Error Response**

In an exception response, the server sets the MSB of the function code to 1. This makes the function code value in an exception response exactly 80 hexadecimal higher than the value would be for a normal response.

- Exception Codes**

Exception Code	Name	Description
01	Illegal Function	The function code received in the query is not an allowable action for the server (or slave).
02	Illegal Data Address	The data address received in the query is not an allowable address for the server (or slave).
03	Illegal Data Value	A value contained in the query data field is not an allowable value for server (or slave).
04	Slave Device Failure	An unrecoverable error occurred while the server (or slave) was attempting to perform the requested action.
05	Acknowledge	The server (or slave) has accepted the request and is processing it, but a long duration of time will be required to do so.
06	Slave Device Busy	Specialized use in conjunction with programming commands. The server (or slave) is engaged in processing a long-duration program command. The client (or master) should retransmit the message later when the server (or slave) is free.
08	Memory Parity Error	The server (or slave) attempted to read record file, but detected a parity error in the memory. The client (or master) can retry the request, but service may be required on the server (or slave) device.
0A	Gateway Path Unavailable	Specialized use in conjunction with gateways, indicates that the gateway was unable to allocate an internal communication path from the input port to the output port for processing the request.

## 6.3. MODBUS Special Register Map

The special register map can be accessed by function code 3, 4, 6 and 16. Also the special register map must be accessed by read/write of every each address (one address).

### 6.3.1. Adapter Identification Special Register (0x1000, 4096)

Address	Access	Type, Size	Description
0x1000(4096)	Read	1word	Vendor ID = 0x029D(669), Crevis. Co., Ltd.
0x1001(4097)	Read	1word	Device type = 0x000C, Network Adapter
0x1002(4098)	Read	1word	Product Code = 0x9010
0x1003(4099)	Read	1word	Firmware revision, if 0x0100, revision 1.00
0x1004(4100)	Read	2word	Product unique serial number
0x1005(4101)	Read	String up to 36byte	Product name string (ASCII) "GN-9386,EtherCAT ID Type,G-Series"
0x1006(4102)	Read	1word	Sum check of EEPROM
0x1010(4112)	Read	2word	Firmware release date
0x101E(4126)	Read	7word - 1word - 1word - 1word - 1word - 1word - 2word	Composite Id of following address 0x1100(4352), Modbus RS232 Node. (Fixed 0x0001) 0x1000(4096), Vendor ID 0x1001(4097), Device type 0x1002(4098), Product code 0x1003(4099), Firmware revision 0x1004(4100), Product serial number

- String Type consists of valid string length (first 1word) and array of characters.

### 6.3.2. Adapter Information Special Register (0x1100, 4352)

Address	Access	Type, Size	Description																								
0x1100(4352)	Read/Write	1word	<p>Master fault action option.</p> <ul style="list-style-type: none"> <li>- 0x00 : Normal option</li> <li>- 0x01 : Master fault action</li> </ul> <p>This option can enable Master fault action option.</p> <p>With master fault action, fault action can be activated with master communication failure. Also, can activate hold last state as IO parameter.</p>																								
0x1102(4354)	Read	1word	Start address of input image word register. =0x0000																								
0x1103(4355)	Read	1word	Start address of output image word register. =0x0800																								
0x1104(4356)	Read	1word	Size of input image word register.																								
0x1105(4357)	Read	1word	Size of output image word register.																								
0x1106(4358)	Read	1word	Start address of input image bit. = 0x0000																								
0x1107(4359)	Read	1word	Start address of output image bit. =0x1000																								
0x1108(4360)	Read	1word	Size of input image bit.																								
0x1109(4361)	Read	1word	Size of output image bit.																								
0x110D(4365)	Read	1word	Current Dip Switch Value and Field Power Status (MSB) ex) Field Power ON, Dip Switch 0x03 = 0x8003																								
0x110E(4366)	Read	up to 33word	Expansion slot's GT-number including GN First 1word is adapter's number, if GN-9386, then 0x9386																								
0x1110(4368)	Read	1word	Number of expansion slot																								
0x1119(4377)	Read	1word	<p>Hi byte is ModBus status, low byte is internal bus status. Zero value means 'no error'.</p> <table border="1"> <thead> <tr> <th>ModBus status</th> <th>Internal bus status(G-Bus)</th> </tr> </thead> <tbody> <tr> <td></td> <td>0x00 : OPERATING</td> </tr> <tr> <td></td> <td>0x01 : COMMUNICATION_FAULT</td> </tr> <tr> <td></td> <td>0x02 : CONNECT_FAULT</td> </tr> <tr> <td></td> <td>0x03 : CONFIG_FAULT</td> </tr> <tr> <td></td> <td>0x04 : NO_EXPANSION</td> </tr> <tr> <td></td> <td>0x05 : NVALID_ATTR_VALUE</td> </tr> <tr> <td></td> <td>0x06 : TOO_MUCH_DATA</td> </tr> <tr> <td></td> <td>0x07 : VENDOR_ERROR</td> </tr> <tr> <td></td> <td>0x08 : NOT_EXPECTED_SLOT</td> </tr> <tr> <td></td> <td>0x09 : CRC_ERROR</td> </tr> <tr> <td></td> <td>0x80 : NO FIELD POWER</td> </tr> </tbody> </table>	ModBus status	Internal bus status(G-Bus)		0x00 : OPERATING		0x01 : COMMUNICATION_FAULT		0x02 : CONNECT_FAULT		0x03 : CONFIG_FAULT		0x04 : NO_EXPANSION		0x05 : NVALID_ATTR_VALUE		0x06 : TOO_MUCH_DATA		0x07 : VENDOR_ERROR		0x08 : NOT_EXPECTED_SLOT		0x09 : CRC_ERROR		0x80 : NO FIELD POWER
ModBus status	Internal bus status(G-Bus)																										
	0x00 : OPERATING																										
	0x01 : COMMUNICATION_FAULT																										
	0x02 : CONNECT_FAULT																										
	0x03 : CONFIG_FAULT																										
	0x04 : NO_EXPANSION																										
	0x05 : NVALID_ATTR_VALUE																										
	0x06 : TOO_MUCH_DATA																										
	0x07 : VENDOR_ERROR																										
	0x08 : NOT_EXPECTED_SLOT																										
	0x09 : CRC_ERROR																										
	0x80 : NO FIELD POWER																										

- After the system is reset, the new "Set Value" action is applied.

### 6.3.3. Expansion Slot Information Special Resister (0x2000, 8192)

Each expansion slot has 0x20(32) address offset and same information structure.

Slot#1 0x2000(8192)~0x201F(8223) Slot#2 0x2020(8224)~0x203F(8255)  
 Slot#3 0x2040(8256)~0x205F(8287) Slot#4 0x2060(8288)~0x207F(8319)  
 Slot#5 0x2080(8320)~0x209F(8351) Slot#6 0x20A0(8352)~0x20BF(8383)  
 Slot#7 0x20C0(8384)~0x20DF(8415) Slot#8 0x20E0(8416)~0x20FF(8447)  
 Slot#9 0x2100(8448)~0x211F(8479) Slot#10 0x2120(8480)~0x213F(8511)  
 Slot#11 0x2140(8512)~0x215F(8543) Slot#12 0x2160(8544)~0x217F(8575)  
 Slot#13 0x2180(8576)~0x219F(8607) Slot#14 0x21A0(8608)~0x21BF(8639)  
 Slot#15 0x21C0(8640)~0x21DF(8671) Slot#16 0x21E0(8672)~0x21FF(8703)  
 Slot#17 0x2200(8704)~0x221F(8735) Slot#18 0x2220(8736)~0x223F(8767)  
 Slot#19 0x2240(8768)~0x225F(8799) Slot#20 0x2260(8800)~0x227F(8831)  
 Slot#21 0x2280(8832)~0x229F(8863) Slot#22 0x22A0(8864)~0x22BF(8895)  
 Slot#23 0x22C0(8896)~0x22DF(8927) Slot#24 0x22E0(8928)~0x22FF(8959)  
 Slot#25 0x2300(8960)~0x231F(8991) Slot#26 0x2320(8992)~0x233F(9023)  
 Slot#27 0x2340(9024)~0x235F(9055) Slot#28 0x2360(9056)~0x237F(9087)  
 Slot#29 0x2380(9088)~0x239F(9119) Slot#30 0x23A0(9120)~0x23BF(9151)  
 Slot#31 0x23C0(9152)~0x23DF(9183) Slot#32 0x23E0(9184)~0x23FF(9215)  
 Slot#33 0x2400(9216)~0x241F(9247) Slot#34 0x2420(9248)~0x243F(9279)

....

Slot#63 0x27C0(10176)~0x27DF(10207)

Address Offset	Expansion Slot#1	Expansion Slot#2	Expansion Slot#3	Expansion Slot#4	.....	Expansion Slot#63
+ 0x00(+0)	0x2000(8192)	0x2020(8224)	0x2040(8256)	0x2060(8288)	.....	0x27C0(10176)
+ 0x01(+1)	0x2001(8193)	0x2021(8225)	0x2041(8257)	0x2061(8289)	.....	0x27C1(10177)
+ 0x02(+2)	0x2002(8194)	0x2022(8226)	0x2042(8258)	0x2062(8290)	.....	0x27C2(10178)
+ 0x03(+3)	0x2003(8195)	0x2023(8227)	0x2043(8259)	0x2063(8291)	.....	0x27C3(10179)
+ 0x04(+4)	0x2004(8196)	0x2024(8228)	0x2044(8260)	0x2064(8292)	.....	0x27C4(10180)
+ 0x05(+5)	0x2005(8197)	0x2025(8229)	0x2045(8261)	0x2065(8293)	.....	0x27C5(10181)
+ 0x06(+6)	0x2006(8198)	0x2026(8230)	0x2046(8262)	0x2066(8294)	.....	0x27C6(10182)
+ 0x07(+7)	0x2007(8199)	0x2027(8231)	0x2047(8263)	0x2067(8295)	.....	0x27C7(10183)
+ 0x08(+8)	0x2008(8200)	0x2028(8232)	0x2048(8264)	0x2068(8296)	.....	0x27C8(10184)
+ 0x09(+9)	0x2009(8201)	0x2029(8233)	0x2049(8265)	0x2069(8297)	.....	0x27C9(10185)
+ 0x0A(+10)	0x200A(8202)	0x202A(8234)	0x204A(8266)	0x206A(8298)	.....	0x27CA(10186)
+ 0x0B(+11)	0x200B(8203)	0x202B(8235)	0x204B(8267)	0x206B(8299)	.....	0x27CB(10187)
+ 0x0C(+12)	0x200C(8204)	0x202C(8236)	0x204C(8268)	0x206C(8300)	.....	0x27CC(10188)
+ 0x0D(+13)	0x200D(8205)	0x202D(8237)	0x204D(8269)	0x206D(8301)	.....	0x27CD(10189)
+ 0x0E(+14)	0x200E(8206)	0x202E(8238)	0x204E(8270)	0x206E(8302)	.....	0x27CE(10190)
+ 0x0F(+15)	0x200F(8207)	0x202F(8239)	0x204F(8271)	0x206F(8303)	.....	0x27CF(10191)
+ 0x10(+16)	0x2010(8208)	0x2030(8240)	0x2050(8272)	0x2070(8304)	.....	0x27D0(10192)
+ 0x11(+17)	0x2011(8209)	0x2031(8241)	0x2051(8273)	0x2071(8305)	.....	0x27D1(10193)

+ 0x12(+18)	0x2012(8210)	0x2032(8242)	0x2052(8274)	0x2072(8306)	.....	0x27D2(10194)
+ 0x13(+19)	0x2013(8211)	0x2033(8243)	0x2053(8275)	0x2073(8307)	.....	0x27D3(10195)
+ 0x14(+20)	0x2014(8212)	0x2034(8244)	0x2054(8276)	0x2074(8308)	.....	0x27D4(10196)
+ 0x15(+21)	0x2015(8213)	0x2035(8245)	0x2055(8277)	0x2075(8309)	.....	0x27D5(10197)
+ 0x16(+22)	0x2016(8214)	0x2036(8246)	0x2056(8278)	0x2076(8310)	.....	0x27D6(10198)
+ 0x17(+23)	0x2017(8215)	0x2037(8247)	0x2057(8279)	0x2077(8311)	.....	0x27D7(10199)
+ 0x18(+24)	0x2018(8216)	0x2038(8248)	0x2058(8280)	0x2078(8312)	.....	0x27D8(10200)
+ 0x19(+25)	0x2018(8217)	0x2038(8249)	0x2058(8281)	0x2078(8313)	.....	0x27D9(10201)
+ 0x1A(+26)	0x201A(8218)	0x203A(8250)	0x205A(8282)	0x207A(8314)	.....	0x27DA(10202)
+ 0x1B(+27)	0x201B(8219)	0x203B(8251)	0x205B(8283)	0x207B(8315)	.....	0x27DB(10203)
+ 0x1C(+28)	0x201C(8220)	0x203C(8252)	0x205C(8284)	0x207C(8316)	.....	0x27DC(10204)
+ 0x1D(+29)	0x201D(8221)	0x203D(8253)	0x205D(8285)	0x207D(8317)	.....	0x27DD(10205)
+ 0x1E(+30)	0x201E(8222)	0x203E(8254)	0x205E(8286)	0x207E(8318)	.....	0x27DE(10206)
+ 0x1F(+31)	0x201F(8223)	0x203F(8255)	0x205F(8287)	0x207F(8319)	.....	0x27DF(10207)

Address Offset	Access	Type, Size	Description
+ 0x02(+2) **	Read	1word	Input start register address of input image word this slot.
+ 0x03(+3) **	Read	1word	Input word's bit offset of input image word this slot.
+ 0x04(+4) **	Read	1word	Output start register address of output image word this slot.
+ 0x05(+5) **	Read	1word	Output word's bit offset of output image word this slot.
+ 0x06(+6) **	Read	1word	Input bit start address of input image bit this slot.
+ 0x07(+7) **	Read	1word	Output bit start address of output image bit this slot.
+ 0x08(+8) **	Read	1word	Size of input bit this slot
+ 0x09(+9) **	Read	1word	Size of output bit this slot
+ 0x0A(+10)**	Read	n word	Read input data this slot
+ 0x0B(+11)**	Read/Write	n word	Read/write output data this slot
+ 0x0E(+14)	Read	1word	GT-number, if GT-1238, returns 0x1238
+ 0x0F(+15)	Read	String up to 74byte	First 1word is length of valid character string. If GT-1238, returns "00 1E 52 54 2D 31 32 33 38 2C 20 38 44 49 2C 20 32 34 56 64 63 2C 20 55 6E 69 76 65 72 73 61 6C 00 00" Valid character size = 0x001E =30 characters, "GT-1238, 8DI, 24Vdc, Universal"
+ 0x10(+16)	Read	1word	Size of configuration parameter byte
+ 0x11(+17)**	Read/Write	n word	Read/write Configuration parameter data, up to 8byte. Refer to A.2 ***
+ 0x17(+23)	Read	2word	Firmware Revision ex) 0x00010010 (Major revision 1 / Minor revision 1, Rev 1.001)
+ 0x19(+25)	Read	2word	Firmware release date.

\* After the system is reset, the new "Set Value" action is applied.

\*\* Nothing of output, input, memory or configuration parameter corresponding slot returns Exception 02.

## 6.4. Supported MODBUS Function Codes

MODBUS Reference Documents

<http://www.modbus.org>

MODBUS Tools

<http://www.modbustools.com>, modbus poll

<http://www.win-tech.com>, modscan32

## 7. TROUBLE SHOOTING

### How to diagnose by LED indicator

LED Status	Cause	Action
All LED turns off	- No power	- Check main power Cable
MOD LED is red	- Occurrence critical error in firmware	- Contact Sales team and send module for repair.
ERROR LED blinking red	- Invalid Configuration	- Check I/O size configuration
IOS LED turns off	- Device may not be powered.	- Check main power Cable
IOS LED flashes red	- Adapter has no expansion module	- Add one or more expansion modules.
IOS LED is red	<p>One or more expansion module occurred in fault state.</p> <ul style="list-style-type: none"> <li>- Detected invalid expansion module ID.</li> <li>- Overflowed Input/Output Size</li> <li>- Too many expansion module</li> <li>- Initialization failure</li> <li>- Communication failure.</li> <li>- Changed expansion module configuration.</li> <li>- Mismatch vendor code between adapter and expansion module.</li> </ul>	<ul style="list-style-type: none"> <li>- Use expansion slot up to 63.</li> <li>- Compose that IO total size is not excess.</li> <li>- Check status of expansion IO connection.</li> <li>- Check the vendor code of module.</li> </ul>
Field Power LED turns off	- Field power is not supplied.	<ul style="list-style-type: none"> <li>- Check main power Cable</li> <li>- Contact Sales team and send module for repair.</li> </ul>
System Power LED turns off	- System power is not supplied.	<ul style="list-style-type: none"> <li>- Check main power Cable</li> <li>- Contact Sales team and send module for repair.</li> </ul>

## How to diagnose when device couldn't communicate network

### Inspection of wrong or omission cable connection

- Check status of cable connection for each node.
- Check that all color matches between connector and cable.
- Check wire omission.

### Terminator resistor

- If terminator resistor is not installed, install terminator resistor
- Check location of terminator resistor

### Configuration of Node address

- Check duplication node address.

### Configuration of Master

- Check configuration of master
- Check whether to do download or don't
- Check composition is right as below Configuration of communication baud rate I/O size  
Configuration of each node

### Ground and environment

- Check ground is contacted
- Check environment factor (temperature, humidity, etc.) is in less than regular limit



## APPENDIX A

### A.1. Product List

No.	GT-Number	Description	ID(hex)
<b>Digital Input Module</b>			
1	GT-1238	8 Points, Universal, 24Vdc, 10RTB	1238
2	GT-123F	16 Points, Universal, 24Vdc, 20P connector	123F
3	GT-12DF	16 Points, Universal, 24Vdc, 18RTB	12DF
4	GT-12FA	32 Points, Universal, 24Vdc, 40P connector	12FA
5	GT-1428	8 Sink Input / 8 Source Output with Diagnostic, 24Vdc	1428
6	GT-1804	4 Points, 120Vac, 10RTB	1804
7	GT-1904	4 Points, 240Vac, 10RTB	1904
<b>Digital Output Module</b>			
8	GT-2318	8 Points, Sink, 24Vdc/0.5A, 10RTB	2318
9	GT-2328	8 Points, Source, 24Vdc/0.5A, 10RTB	2328
10	GT-221F	16 Points, Sink, 24Vdc/0.3A, 20P connector	221F
11	GT-222F	16 Points, Source, 24Vdc/0.3A, 20P connector	222F
12	GT-225F	16 Points, Sink, 24Vdc/0.3A, 18RTB	225F
13	GT-226F	16 Points, Source, 24Vdc/0.3A, 18RTB	226F
14	GT-22BA	32 Points, Sink, 24Vdc/0.3A, 40P connector	22BA
15	GT-22CA	32 Points, Source, 24Vdc/0.3A, 40P connector	22CA
16	GT-2418	8 Channels Sink Output with Diagnostics	2418
17	GT-2428	8 Channels Source Output with Diagnostics	2428
18	GT-2618	8 Points, Sink, 24Vdc/2A, 10RTB	2618
19	GT-2628	8 Points, Source, 24Vdc/2A, 10RTB	2628
20	GT-2734	4 Points, MOS Relay, 240Vdc/ac, 0.5A, 10RTB	2734
21	GT-2738	8 Points, MOS Relay Output Terminal, 240Vdc, 0.5A	2738
22	GT-2744	4 Points, Relay, 24Vdc/2A, 240Vac/2A, 10RTB	2744
23	GT-2764	4 Points, MOS Relay, 24Vdc/ac, 2A, 10RTB	2764
24	GT-2768	8 Points, Relay Output Terminal, 24Vdc/ac, 2A	2768
25	GT-2784	4 Points, MOS Relay, 110Vdc/ac, 1A, 10RTB	2784
26	GT-2788	8 Points, Relay Output Terminal, 110Vdc/ac, 1A	2788
<b>Analog Input Module</b>			
27	GT-3002	2ch load cell input unit, strain gauge	3002
28	GT-3114	4 Channels, 0~20, 4~20mA, 12bits, 10RTB	3114
29	GT-3154	4 Channels, 0~20, 4~20mA, 16bits, 10RTB	3154
30	GT-3118	8 Channels, 0~20, 4~20mA, 12bits, 10RTB	3118
31	GT-3158	8 Channels, 0~20, 4~20mA, 16bits, 10RTB	3158
32	GT-311F	16 Channels, 0~20, 4~20mA, 12bits, 20P connector	311F
33	GT-315F	16 Channels, 0~20, 4~20mA, 16bits, 20P connector	315F
34	GT-317F	16 Channels, 0~20, 4~20mA, 12bits, 18RTB	317F
35	GT-319F	16 Channels, 0~20, 4~20mA, 16bits, 18RTB	319F
36	GT-3424	4 Channels, 0~10, 0~5, 1~5Vdc, 12bits, 10RTB	3424
37	GT-3464	4 Channels, 0~10, 0~5, 1~5Vdc, 16bits, 10RTB	3464
38	GT-3428	8 Channels, 0~10, 0~5, 1~5Vdc, 12bits, 10RTB	3428

39	GT-3468	8 Channels, 0~10, 0~5, 1~5Vdc, 16bits, 10RTB	3468
40	GT-342F	16 Channels, 0~10, 0~5, 1~5Vdc, 12bits, 20P connector	342F
41	GT-346F	16 Channels, 0~10, 0~5, 1~5Vdc, 16bits, 20P connector	346F
42	GT-347F	16 Channels, 0~10, 0~5, 1~5Vdc, 12bits, 18RTB	347F
43	GT-349F	16 Channels, 0~10, 0~5, 1~5Vdc, 16bits, 18RTB	349F
44	GT-3704	4 Channels, RTD, 10RTB	3704
45	GT-3708	8 Channels, RTD, 20P connector	3708
46	GT-3804	4 Channels, Thermocouple, 10RTB	3804
47	GT-3808	8 Channels, Thermocouple, 20P connector	3808
48	GT-3714	4 Channels, TEMP. Controller, RTD Input, SSR Output	3714
49	GT-3734	4 Channels, TEMP. Controller, RTD Input, Current Output	3734
50	GT-3814	4 Channels, TEMP. Controller, TC Input, SSR Output	3814
51	GT-3834	4 Channels, TEMP. Controller, TC Input, Current Output	3834
52	GT-3901	AC Measurement	3901
53	GT-3914	4 Channels, Differential, 0~20, 4~20, +/-20mA, 12Bits, 10RTB	3914
54	GT-3934	4 Channels, Differential, 0~20, 4~20, +/-20mA, 16Bits, 10RTB	3934
55	GT-3918	8 Channels, Differential, 0~20, 4~20, +/-20mA, 12Bits, 18RTB	3918
56	GT-3938	8 Channels, Differential, 0~20, 4~20, +/-20mA, 16Bits, 18RTB	3938
57	GT-3924	4 Channels, Differential, 0~5, 0~10, +/-5, +/-10Vdc, 12Bits, 10RTB	3924
58	GT-3944	4 Channels, Differential, 0~5, 0~10, +/-5, +/-10Vdc, 16Bits, 10RTB	3944
59	GT-3928	8 Channels, Differential, 0~5, 0~10, +/-5, +/-10Vdc, 12Bits, 18RTB	3928
60	GT-3948	8 Channels, Differential, 0~5, 0~10, +/-5, +/-10Vdc, 16Bits, 18RTB	3948
<b>Analog Output Module</b>			
61	GT-4114	4CH, 0~20mA, 12Bits, 10RTB	4114
62	GT-4154	4CH, 0~20mA, 16Bits, 10RTB	4154
63	GT-4118	8CH, 0~20mA, 12Bits, 10RTB	4118
64	GT-4158	8CH, 0~20mA, 16Bits, 10RTB	4158
65	GT-4214	4 Channels, Current Output, 4~20mA, 12bits	4214
66	GT-4254	4 Channels, Current Output, 4~20mA, 16bits	4254
67	GT-4218	8 CHANNELS CURRENT OUTPUT, 4~20mA, 12BIT	4218
68	GT-4258	8 CHANNELS CURRENT OUTPUT, 4~20mA, 16BIT	4258
69	GT-4424	4CH, 0~10Vdc, 12Bits, 10RTB	4424
70	GT-4464	4CH, 0~10Vdc, 16Bits, 10RTB	4464
71	GT-4428	8CH, 0~10Vdc, 12Bits, 10RTB	4428
72	GT-4468	8CH, 0~10Vdc, 16Bits, 10RTB	4468
73	GT-442F	16CH, 0~10Vdc, 12Bits, 20P Connector	442F
74	GT-446F	6CH, 0~10Vdc, 16Bits, 20P Connector	446F
75	GT-447F	16CH, 0~10Vdc, 12Bits, 18RTB	447F
76	GT-449F	16CH, 0~10Vdc, 16Bits, 18RTB	449F
77	GT-4524	AO 4 CHs, ±10Vdc, 12Bits, 10RTB	4524
78	GT-4564	AO 4 CHs, ±10Vdc, 16Bits, 10RTB	4564
<b>Special Module</b>			
79	GT-5102	2CH, Encoder, Input, 5Vdc, 10RTB	5102
80	GT-5112	High Speed Counter, 2CHs, 24Vdc, Encoder Input, 10RTB	5112
81	GT-5114	High Speed Counter, 4CHs, 24Vdc, Encoder Input, 10RTB	5114
82	GT-5211	1CH, RS 232, RTS/CTS, Full Duplex Type, 10RTB	5211

83	GT-5212	2CH, RS 232, Full Duplex Type, 10RTB	5212
84	GT-5221	1CH, RS 485, Full Duplex Type, 10RTB	5221
85	GT-5231	1CH, RS 485, Half Full Duplex Type, 10RTB	5231
86	GT-5232	2CH, RS 485, Half Full Duplex Type, 10RTB	5232
87	GT-5352	2CH, Synchronous Serial Interface Input, 10RTB	5352
88	GT-5442	PWM Output, 2CHs, 0.5A/24Vdc, Source, 18RTB	5442
89	GT-5444	PWM Output, 4CHs, 0.5A/24Vdc, Source, 18RTB	5444
90	GT-5642	Pulse Output, 2CHs, 0.5A/24Vdc, Source, 18RTB	5642
91	GT-5652	Pulse Output, 2CHs, RS422 (Differential), 18RTB	5652
92	GT-5521	1CH, Stepper Module	5521
<b>Power Module</b>			
93	GT-7408	Shield Module	7408
94	GT-7508	Common for 0Vdc	7508
95	GT-7511	Power Expansion, In 24Vdc, Out 1A/5Vdc	7511
96	GT-7518	Common for 24Vdc	7518
97	GT-7588	Common for 0Vdc, 24Vdc	7588
98	GT-7641	Field Power, 5/24/48 Vdc, 110/220 Vac	7641
99	GT-7151	Noise Filter Module, 18RTB, None ID Type	7151
100	GT-7851	Noise Filter Module, 18RTB, ID Type	7851

## A.2. Glossary

- System Power : The power for starting up CPU.
- Field Power : The power for input and output line.
- Terminator Resistor : Resistor for prevention reflected wave.
- EDS : Electronic Data Sheet.
- Sink : The method of in/output power supply if a device has no power source.
- Source : The method of in/output power supply if a device has the power source.